



# THX-CDL

## Control & Data Logger

USER & INSTALLATION MANUAL V1.2012



# Contents

## PRESENTATION

Summary of Features	3
---------------------	---

## INSTALLATION

Safety Precautions	4
THX Unit	4
Sensors	4
Alarm Relay	4
Light Relay	4
Power Connection and Wiring Diagram	5
Battery	5
Wall & Panel Mount	6
Panel Mount diagrams	7

## THX OPERATION

<b>1.0 Main Screen</b>	9
1.1 Status Screen	9
<b>2.0 Settings Screens</b>	10
2.1 System	10
• Cold-room temperature set point	
• Cold-room Thermostat Differential	
• Switch Delay	
• Fan Mode	
• Fan Enable Temperature	
• Fan Stop Delay	
• Defrost Mode	
2.2 Set Clock	12
2.3 Scale	12
2.4 Calibration	12
2.5 Keypad	13
2.6 Language	13
2.7 Sample period	14
2.8 Password	14
2.9 Door	14
2.10 Network	15
2.11 Contrast	15
2.12 Energy Saving	15
2.13 Factory Settings	15

<b>3.0 Defrost Screen</b>	16
3.1 Manual Defrost	16
3.2 Defrost (cycle 1-6)	16
3.3 Defrost (cycle 7-12)	17
3.4 Defrost Schedule	18

<b>4.0 Alarm Screen</b>	18
4.1 Diagnostic Screen	20
4.2 Diagnostic Screen 2	21

<b>5.0 Plot Screen</b>	21
5.1 History	22

## USB

1. Download Data	23
2. Download Setup	23
3. Upload Setup	23
4. Service	23

## WEB SERVER

1. Live Data	25
2. Setup	26
3. User	27
4. Graph	27
5. Network	28
6. Download	28

## SPECIFICATION

# Presentation



## SUMMARY OF FEATURES

- Power Supply 100 – 240V AC Mains
- Universal panel mount or wall mount box
- EN12830 certified
- CE tested
- On Board Web Server (IP addressable)
- Large data storage capacity
- USB Firmware Upgrade Functionality
- Backward compatible with old sensors (PT 100 terminated with RJ 11)
- IP54 Rated
- Module Auto-Detect and self-configuration

### Controller

- Digital display of room and product temperature
- Digital display of evaporator
- Cold-room thermostat adjustable in 1°C steps with adjustable differential
- Compressor switching limiter for short-cycling prevention
- Fan enable thermostat
- Fully programmable defrost with adjustable duration, termination temperature and dwell period
- Manual defrost activation and override
- Energy saving mode

### Datalogger

- Temperature from each channel can be set to sample every 1/5/15/30/60 minutes and stored to an internal databank
- Contents of internal databank can be transferred to the USB Flash Memory and viewed or transferred to the PC via website
- Battery Back-up up to 6hrs

### Alarm

- 2-Stage high and low level alarms with mute facility
- Stage 1 temperature threshold with trigger delay
- Stage 2 limit temperature with immediate trigger
- Alarm history record for low alarm, high alarm and power fail
- Battery back-up for power-fail operation
- Summary screen for Alarm Overview

*Note: The information supplied in this manual is for guidance only – no part of this may be used for any agreement, whether express or implied, or to form any contract.*

# Installation

*Note: This installation procedure is for guidance only, and its suitability should be verified by the installer.*

## SAFETY PRECAUTIONS

The following safety precautions are strongly recommended:

1. Before attempting to install and operate the unit, read the instruction and installation manual carefully.
2. Installation and any maintenance should only be carried out by suitably qualified personnel.
3. It is recommended that the unit be connected to the mains supply via a suitably rated isolating switch.
4. **WARNING: When the unit is connected to the mains supply and the cover is open, the circuits at mains voltage will be exposed.** Therefore when installing the unit, ensure all required connections (including battery connected, if included), are made and covers replaced before turning on the mains supply. Ensure that all the connections made are secure. If any maintenance work e.g. installing a new battery, is required ensure that the unit is isolated from the mains supply before removing the cover. **Never leave the unit unattended if the cover has been removed and the mains supply is connected.**
5. Do not exceed unit ratings as shown on the ratings label.
6. It is advisable to route mains cables away from low voltage or sensor cables.

### (i) THX Unit

*Note: For viewing comfort, the unit should be positioned at eye level. The ambient temperature of the unit is (0°C to +40°C). It is always good practice to keep electronic equipment away from cold, heat and electrical plant, as extremes of temperature may reduce the lifetime of the device, and heavy electrical loads, switches, relays or contactors too close to the device may cause electrical and electro-magnetic interference when switched on or off.*

### (ii) Sensors

The THX may be used with a variety of sensors of different cable lengths. If required, sensors are available with extended cable lengths or alternatively, sensor extenders are available also in a variety of lengths. If the sensors need to be extended, but factory-made extenders are not available, they can be extended using a suitable 3 or 4 core cable, according to the diagram shown below

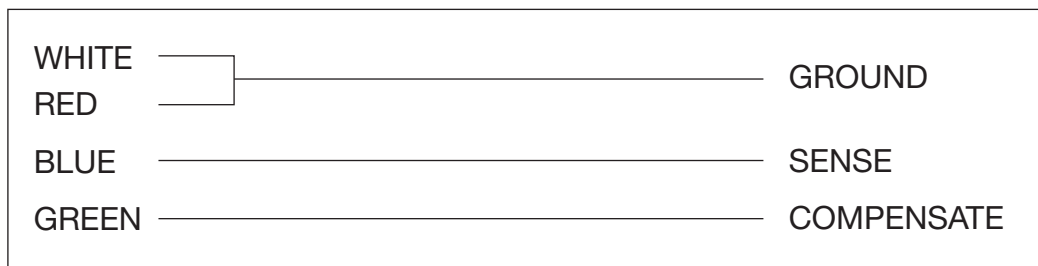

- Install the ROOM sensor in the cold-room, ensuring that it is not too close to either the evaporator fan or the door. Position the sensor such that it reads the average cold-room temperature.
- Attach the EVAP sensor to the evaporator fins, ensuring that it is not too close to the defrost heater elements. Ideally, the sensor should measure the temperature of the evaporator coil, and should not be directly affected by the heater element. Therefore it is important to ensure good heat conduction between the evaporator tube and the sensor.
- Install the product sensor either to measure the air temperature or product temperature (or simulated product), as required, depending on the application. The THX uses the temperature measured by this sensor for logging purposes only.

Please note however, that as with all PT100 sensor applications, a good connection is vital. It is therefore recommended that wherever there is any doubt, a factory extended sensor or sensor extender should be used.

### (iii) Alarm Relay

*Note: The alarm relays are 3 contact arrangements which are isolated (volt-free). These relays may be used to trigger an external bell, warning lamp or digital communicator (telephone dialler).*

Max rating of Alarm relays is 5A @ 240 VAC.

If the external device is used, connect the alarm as appropriate, according to the diagram opposite.

### (iv) Light Relay

Max rating of Light relay is 5A @ 240 VAC.

# Installation

## (v) Power Connections and Wiring Diagram

*Note: This device should be properly earthed. Flexible wires simplify connection to the terminals. All connections should be secure and adequately tightened. It is good practice to keep mains cables away from sensor cables and other low voltage signal cables.*

Connect the supply to the unit, as per diagram below, using the appropriate input voltage according to the application.

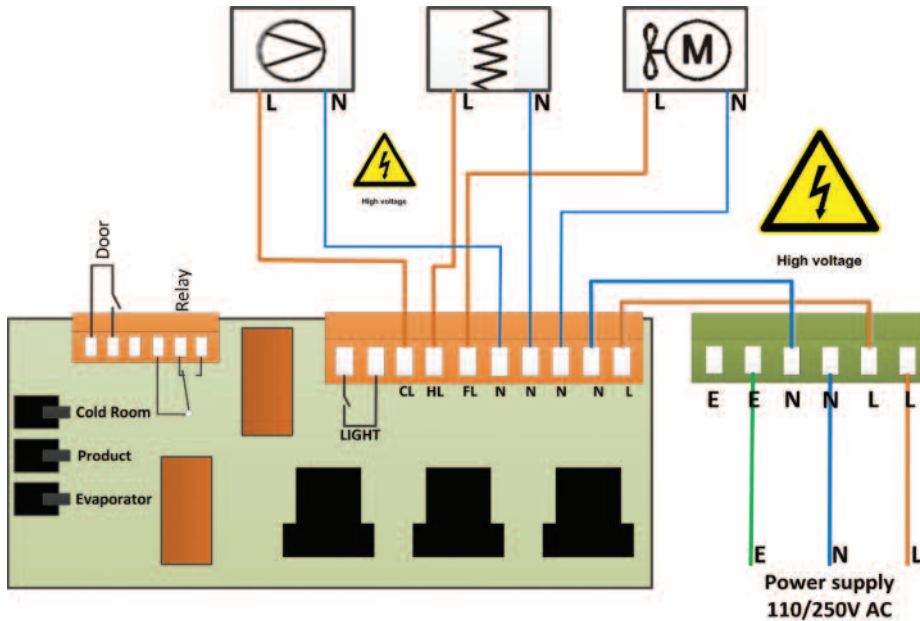

## (vi) Battery

The battery supplied is a 3.7V Lithium-polymer rechargeable battery and is plugged in but switched OFF. This should be switched ON after installation. See picture below. This battery is not essential for the system operation, but is used in the case of power failure, thereby continuing to log the 12 sensor inputs for approximately 6 hours.

The system parameters will remain intact, in the event of a power failure, however all interface options (Ethernet, screen, keypad options, USB etc. will not function as normal)

It is recommended that the battery is changed every 24 months, in order to maintain good power failure backup operation. When replacing, ensure that the type of rechargeable battery used is as specified.

(3.7V Lithium-polymer rechargeable battery)

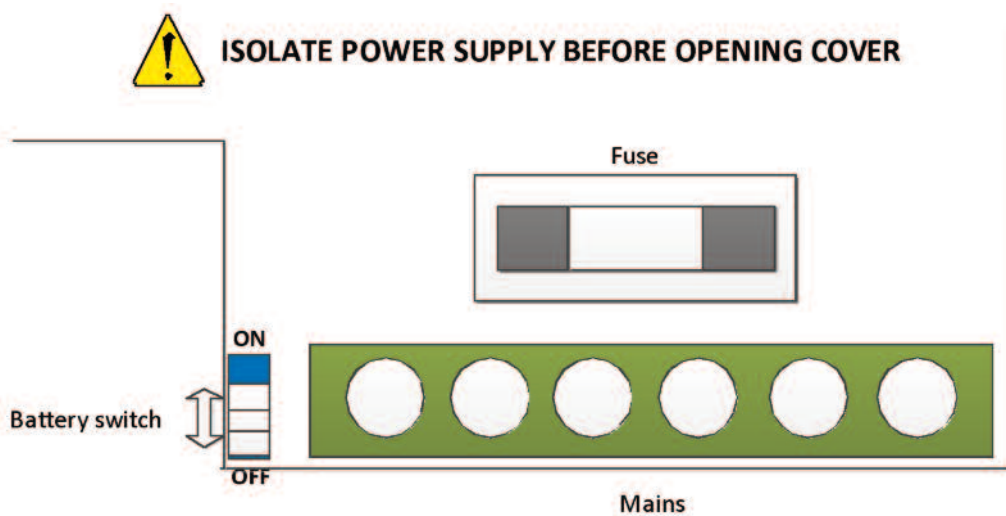

# Installation

## WALL MOUNT

1. Drill four holes in the wall, according to the template and insert the wall plugs
2. Remove the Front Lid by unscrewing two screws
3. Disconnect the modules
4. Separate the front cover by unscrewing two screws
5. Remove the required knock outs from Back Box for the cables to pass through (always separate front cover before removing the knock outs)
6. Insert the cable glands
7. Screw in the Back Box to the wall
8. Pass the cables through the glands
9. Mount the Front Cover on the Back Box
10. Insert the modules
11. Connect the power supply cable and sensors
12. Tighten the cable glands
13. Mount the front lid

## PANEL MOUNT (required panel mount kit)

1. Cut a hole in the panel with the described dimensions, *(see page 7)*
2. Remove the Front Lid unscrewing two screws
3. Disconnect the modules
4. Separate the front cover by unscrewing two screws
5. Remove the required knock outs from Back Box for the cables to pass through (always separate front cover before removing the knock outs). Ethernet cable can be passed through the hole which is under the label on the front cover *(see picture below)*
6. Attach the Panel Mount Seal, ensure that it is on the right position
7. Insert the Back Box into the panel cut out
8. Attach the four Panel Mount Fixing Clips (supplied), to the four studs at either side of the unit, *(see page 7)*.
9. Tighten the four Panel Mount Fixing Screws
10. Insert the cable glands
11. Pass the cables through the glands
12. Mount the Front Cover on the Back Box
13. Insert the modules
14. Connect the power supply cable and sensors
15. Tighten the cable glands
16. Mount the front lid

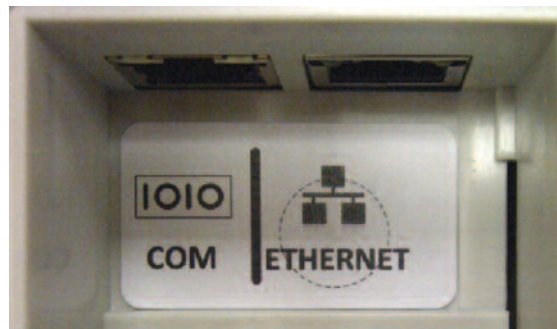

# Installation

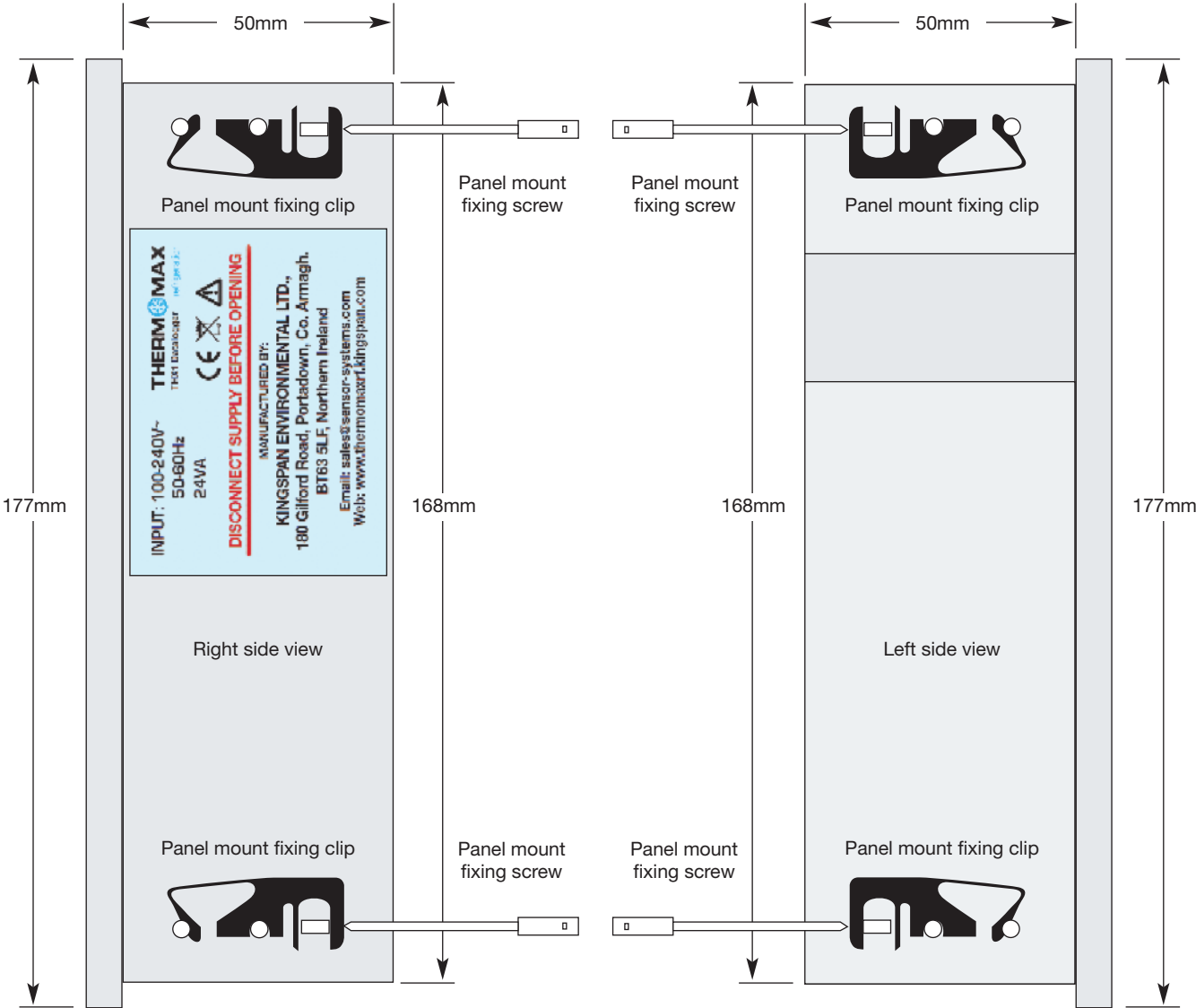
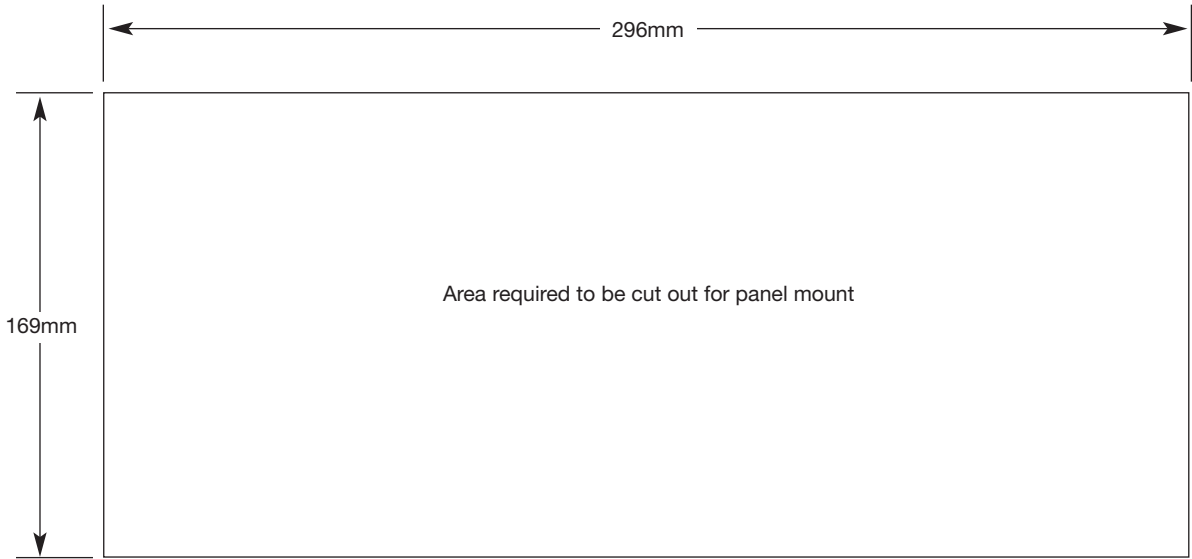

# THX-CDL Operation

In order to fully understand the operation of the unit, this section should be read carefully.

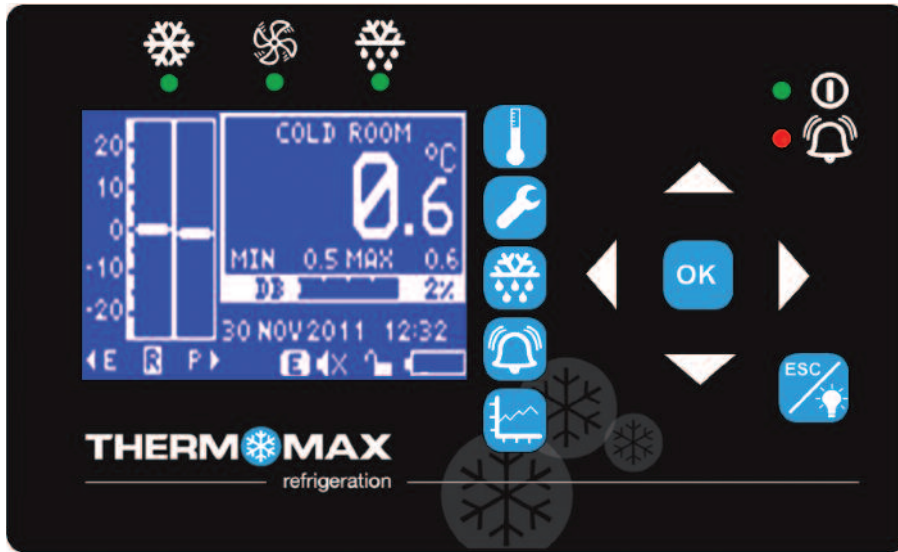

## (i) Graphic LCD Display

Displays all the information. The contrast is adjustable to suit the user. (Refer to section 2.11)







## (ii) Navigation Keys

The six keys are used to navigate through the unit's menus, allowing for easy access to the THX many options and settings.

The four arrow keys select an option in the displayed menu, the  key select the menu and the  key returns to the previous menu.

## (ii) Function Keys

There are six function keys on the THX2 unit:

- |   |  |
|---|--|
|  Main Screen     |  Alarm Screen   |
|  Settings Screen |  Plot Screen  |
|  Defrost Screen  |  Esc/Light Switch (hold for 5 seconds to switch ON/OFF the light) |

## (iii) Indicators

- |  |   |
|--|---|
|  Power ON/OFF |  Fan     |
|  Alarm        |  Defrost |
|  Compressor   |   |



# THX-CDL Operation

## 1.0 MAIN SCREENS

To enter the Main Screen press the  key.

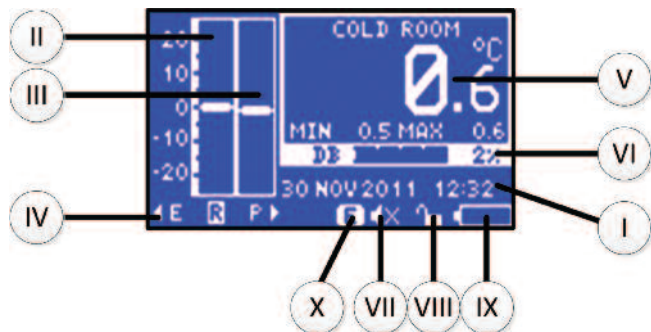

- I. Date and clock display
- II. Cold-room temperature bar graph display
- III. Product temperature bar graph display
- IV. Display select indicator  
The highlighted box indicates which temperature is displayed  
The options are: E – Evaporator  
R – Room (cold room)  
P – Product (temperature only for logging purposes)

To change selection, use the keys, as appropriate.

*Note: The evaporator temperature view is momentary only. The display will revert back to room temperature when the select key is released.*

- V. Digital display of selected temperature, with minimum/maximum indication.  
The minimum and maximum values are daily values and are reset at midnight every day.
- VI. Internal databank indicator. This indicates the percentage 'used', in both bargraph and digital form.
- VII. Buzzer Mute indicator
- VIII. Settings lock indicator
- IX. Battery status
- X. Energy saving mode indicator

### 1.1 Status Screen

This screen displays the status of the Compressor, Door, Heater and Fan.

To enter the Status Screen press the  key twice.



# THX-CDL Operation

## 2.0 SETTINGS SCREEN

To enter the Settings Screen press the  key.

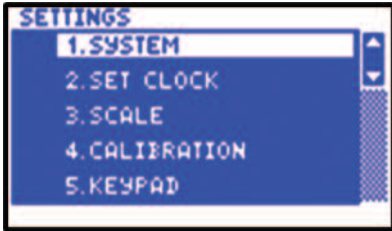



### 2.1 System

Select System from the Setting Screen and confirm selection using the  key to enter the System Settings.

#### Cold-room temperature set point (-50°C to +50°C)

This is the thermostat temperature indicating the required cold-room temperature.

Select 'Coldroom Temp Set' using the  key and set the required temperature using  and  keys.

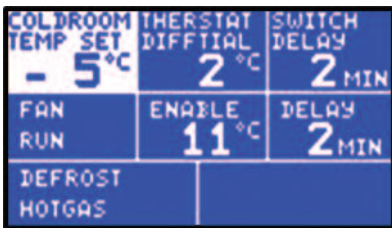



#### Cold-room Thermostat Differential (0°C to 10°C)

This is the differential (hysteresis) of the thermostat.



*Note: if a differential of 2°C is selected, assuming a cold-room temperature of -8°C, the temperature has to rise to -6°C before the compressor will switch on, and then drop to -10°C before the compressor will switch off. The cold-room temperature deviation in this case will be -10°C to -6°C, i.e. 4°C.*

*In general, the temperature deviation allowed by the system will always be twice the selected differential. In real life, the true temperature deviation will usually be more than the above, due to the delay in the response of the plant.*

Select 'Therstat Diffial' using the  key and set the required temperature using  and  keys.

#### Switch Delay (0 – 99 min.)

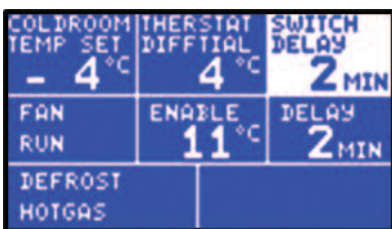

This is a time delay to prevent the compressor from short-cycling. Each time the compressor is switched on, the timer is triggered. The compressor will subsequently not be allowed to switch on until the delay has expired.

Select 'Switch Delay' using the  key and set the required delay time using  and  keys.



# THX-CDL Operation

## Fan Mode

Select 'Fan' using the  key and set the fan to RUN or STOP using the  and  keys.



COLDROOM TEMP SET	THERSTAT DIFFTIAL	SWITCH DELAY
- 4 °C	4 °C	3 MIN
FAN RUN	ENABLE 11 °C	DELAY 2 MIN
DEFROST		
HOTGAS		

COLDROOM TEMP SET	THERSTAT DIFFTIAL	SWITCH DELAY
- 4 °C	4 °C	3 MIN
FAN STOP	ENABLE 11 °C	DELAY 2 MIN
DEFROST		
HOTGAS		

## Fan Enable Temperature

This is a thermostat, which disables fan operation any time the evaporator temperature exceeds this pre-set value. Its main use is to prevent warm air from being transferred into the cold-room immediately after a defrost cycle.





The fan thermostat has a built-in differential of +/-1°C, i.e. when the pre-set temperature is 0°C, the fan will switch on when the evaporator drops to -1°C, and will switch off when it rises to +1°C.

Select 'Fan Enable' using the  key and set the required temperature using the  and  keys.

COLDROOM TEMP SET	THERSTAT DIFFTIAL	SWITCH DELAY
- 4 °C	4 °C	3 MIN
FAN RUN	ENABLE 11 °C	DELAY 2 MIN
DEFROST		
HOTGAS		



## Fan Stop Delay

This feature concerns users who utilise the 'FAN STOP' mode of operation. When a defrost cycle terminates in 'FAN STOP' mode, the fan will switch on only after the compressor switches on and this FAN DELAY period has expired.

Select 'Fan' using the  key and set the fan to STOP using the  key. Select 'Delay' using the  key and set the required delay time using the  and  keys.

COLDROOM TEMP SET	THERSTAT DIFFTIAL	SWITCH DELAY
- 4 °C	4 °C	3 MIN
FAN STOP	ENABLE 12 °C	DELAY 2 MIN
DEFROST		
HOTGAS		



## Defrost Mode 'ELECTRONIC'

Select 'Defrost' using the  key and set the defrost to ELECTR using the  key.

COLDROOM TEMP SET	THERSTAT DIFFTIAL	SWITCH DELAY
- 4 °C	4 °C	3 MIN
FAN RUN	ENABLE 12 °C	DELAY 2 MIN
DEFROST ELECTR		

# THX-CDL Operation

## Defrost Mode 'HOT GAS'

Select 'Defrost' using the  key and set the defrost to HOTGAS using the  key.

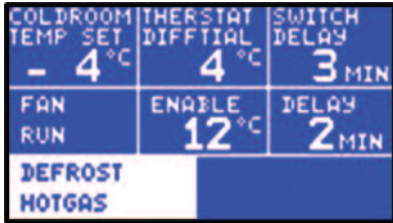

## 2.2 Set Clock

The Set Clock screen allows the user to change the time and date settings of the unit.

Select Set Clock from the Setting Screen and confirm selection using the  key.

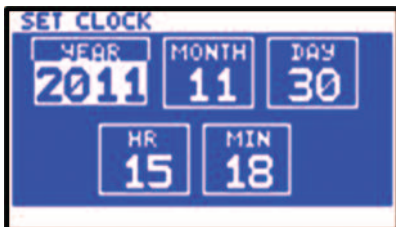

The highlighted parameter is adjusted by pressing the  or  key. The parameters are Year, Month, Day, Hour and Minutes.

To change any of these, press the  or  key. Press the  key to confirm the changes and back to the previous screen.

## 2.3 Scale

Select Scale from the Setting Screen and confirm selection using the  key.

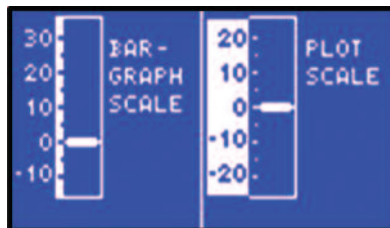
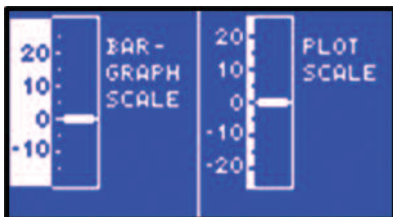

## 2.4 Calibration

Calibration trimming allows qualified personnel to adjust the Sensor Measurement by  $\pm 3^{\circ}\text{C}$  /  $\pm 3\%r\text{H}$ . A known reference value should be used.

Select Calibration from the Setting Screen and confirm selection using the  key.

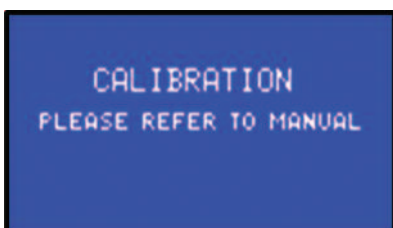

To enter the Calibration Trimming screen, press and hold the  key for 8 seconds.

## THX-CDL Operation



Use the keys to move to the channel that requires calibration trimming. Then use the or key to adjust the current temperature reading to the reference value read at the input.

### 2.5 Keypad

Select Keypad from the Setting Screen and confirm selection using the key.

Enter the four digit password using the keys to access the menu. Confirm using the key.



To lock, press the key.

To unlock, press the key.

When the keypad is locked, the THX enter into a security mode, which renders the unit 'tamper-proof'.

Default password: 0000

### 2.6 Language Select

Select Language Select from the Setting Screen and confirm selection using the key.

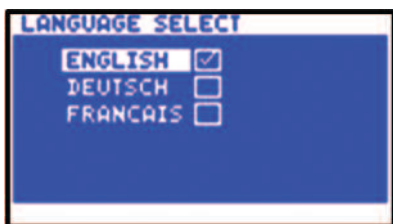

The language used by the THX to communicate the information may be selected here, i.e. English, German and French.

Use the or key to select the required language and then confirm the selection using the key.

✓ indicates the language that is currently selected.



Press the key to exit

# THX-CDL Operation

## 2.7 Sample Period

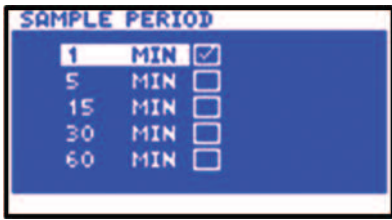
Select Sample Period from the Setting Screen and confirm selection using the  key.



Use the  or  key to select the required sample period and then confirm the selection using the  key.

✓ indicates the sample period that is currently selected.

Press the  key to exit.

## 2.8 Password

Select Password from the Setting Screen and confirm selection using the  key.

The Password screen allows the user to change the password.

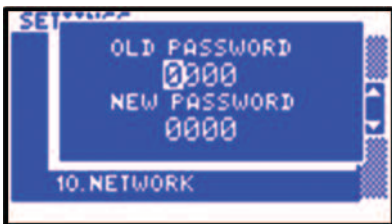

Enter the old and new password using the , , ,  keys and confirm using the  key.

Confirmation screen with new password will appear.

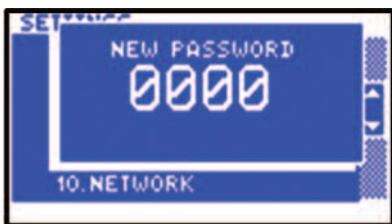

## 2.9 Door

Select Door from the Setting Screen and confirm selection using the  key.

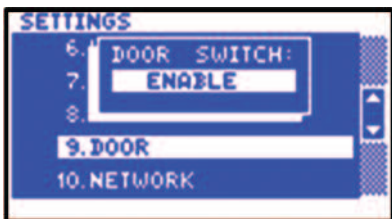

This screen allows the user to Enable or Disable the door switch.

Use the ,  key to enable or disable the door and confirm using  key.

# THX-CDL Operation

## 2.10 Network

Select Network from the Setting Screen and confirm selection using the  key.

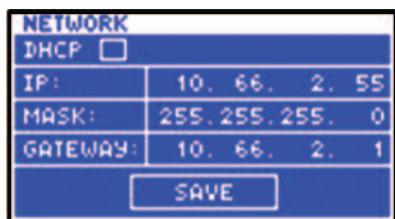

Please enter your network details or choose DHCP for Automatic Network Configuration.

To set Automatic Network Configuration, use the  key to select DHCP and use the  key to select or deselect this option.

 Indicates that the DHCP is OFF.

 Indicates that the DHCP is ON.

Select  and use the  key to save the settings.

## 2.11 Contrast

Select Contrast from the Setting Screen and confirm selection using the  key.

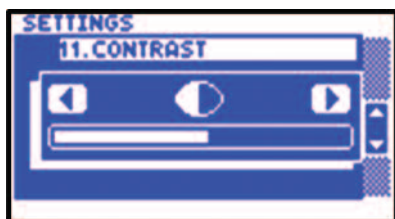

Use the   keys to adjust the contrast

## 2.12 Energy Saving

Select Energy Saving from the Setting Screen and confirm selection using the  key.

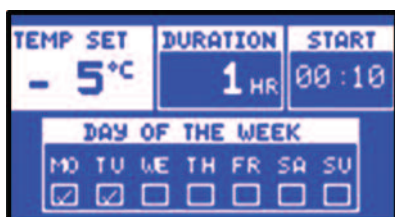

Select the required temperature, duration and start time using the     keys and set the schedule.

## 2.13 Factory Settings

Select Factory Settings from the Setting Screen and confirm selection using the  key.

# THX-CDL Operation

## 3.0 DEFROST SCREEN

### 3.1 Manual Defrost

To enter the Manual Defrost Screen press the  key from the Main Screen.

Set the required Defrost Time using  and  key. Defrost will start immediately.



### 3.2 Defrost (cycle 1 - 6)

To enter the defrost settings cycle 1 - 6 press the  key twice from the Main Screen.

#### Defrost 'Duration Time Cycle 1 - 6'

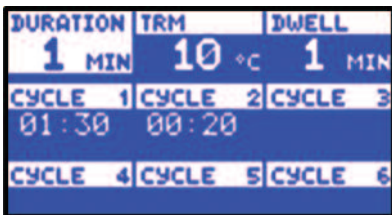

The duration of the defrost cycles can be set here.

Select 'Duration' using the  key and set the required Defrost Duration Time using  and  key.



#### Defrost 'Termination Temperature Cycle 1 - 6'

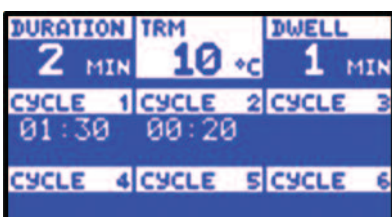

If the evaporator temperature exceeds this pre-set during a defrost cycle it will end the current defrost cycle.

Select 'TRM' using the  key and set the required temperature using  and  key.



#### Defrost 'Dwell Cycle 1 - 6'

After a defrost cycle, whether the cycle has terminated by time or temperature, a dwell period can be programmed (for drain off), or set to '0' (no dwell).

Select 'Dwell' using the  key and set the required time using  and  key.

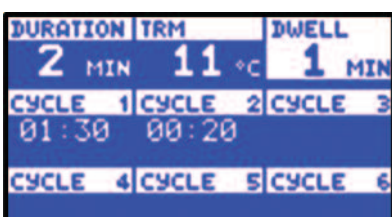





# THX-CDL Operation

## Defrost 'Cycles start time 1 - 6'

Once the defrost duration, termination temperature and dwell periods have been set, they apply to all start times within that defrost group. Each defrost cycle is off (inactive) when the display for that cycle is blank.

Select 'Cycle 1 - 6' using the  key and set the required start time using  and  key.

DURATION	TRM	DWELL
2 MIN	11 °C	2 MIN
CYCLE 1	CYCLE 2	CYCLE 3
01:30	00:20	
CYCLE 4	CYCLE 5	CYCLE 6

## 3.3 Defrost (cycle 7 - 12)

To enter the defrost settings cycle 7 - 12 press the  key twice from the Main Screen.

### Defrost 'Duration Time Cycle 7 - 12'

The duration of the defrost cycles can be set here.

Select 'Duration' using the  key and set the required Defrost Duration Time using  and  key.

DURATION	TRM	DWELL
8 MIN	10 °C	2 MIN
CYCLE 7	CYCLE 8	CYCLE 9
18:30		
CYCLE 10	CYCLE 11	CYCLE 12
	05:30	

### Defrost 'Termination Temperature Cycle 7 - 12'



If the evaporator temperature exceeds this pre-set during a defrost cycle it will end the current defrost cycle.

Select 'TRM' using the  key and set the required temperature using  and  key.

DURATION	TRM	DWELL
9 MIN	10 °C	2 MIN
CYCLE 7	CYCLE 8	CYCLE 9
18:30		
CYCLE 10	CYCLE 11	CYCLE 12
	05:30	

### Defrost 'Dwell Cycle 7 - 12'

After a defrost cycle, whether the cycle has terminated by time or temperature, a dwell period can be programmed (for drain off), or set to '0' (no dwell).



Select 'Dwell' using the  key and set the required time using  and  key.

DURATION	TRM	DWELL
9 MIN	11 °C	2 MIN
CYCLE 7	CYCLE 8	CYCLE 9
18:30		
CYCLE 10	CYCLE 11	CYCLE 12
	05:30	

# THX-CDL Operation

## Defrost 'Cycles start time 7 - 12'

Once the defrost duration, termination temperature and dwell periods have been set, they apply to all start times within that defrost group. Each defrost cycle is off (inactive) when the display for that cycle is blank.

Select 'Cycle 7 - 12' using the  key and set the required start time using  and  key.



## 3.4 Defrost Schedule

To enter the defrost schedule press the  key four times from the Main Screen.



Select required days for the cycles 1-6 or 7-12 using the  key and switch defrost ON using  or OFF using  key.

## 4.0 ALARM SCREEN

To enter the Alarm Screen press the  key from the Main Screen.

### Status Window

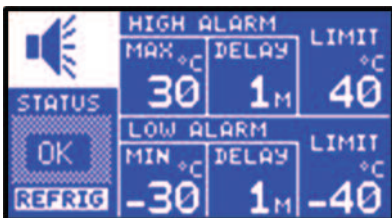

This window shows the current state of the system. If there are any warnings or messages, they will be displayed here. If everything is in good working condition, the message 'OK' is displayed here.

### Alarm Mute

Select Status using the  key and press the  key.

Select Mute using  and  key and confirm by pressing the  key. Enter the four digit pin code and press the  key.

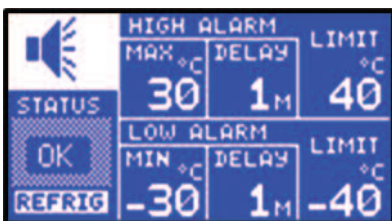



*Note: Also, pressing any key the alarm will be temporarily muted for 3 minutes. When the alarm system is reset, either manually or by the temperatures dropping back within their allowed limits, the alarm mute will automatically be cancelled.*

# THX-CDL Operation



## Alarm Reset

Select Status using the  key and press the  key.

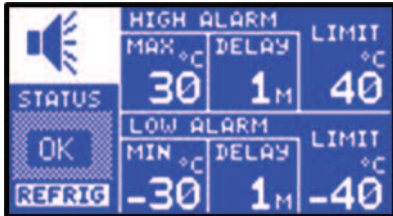
Select Reset using  and  key and confirm by pressing the  key. Enter the four digit pin code and press the  key.



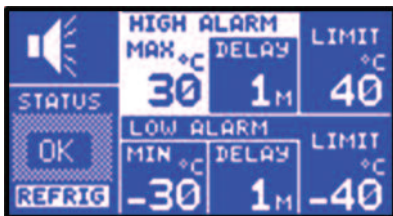

## High Alarm Stage 1 Temperature (-99°C to +150°C)/Humidity (0%rH to 100%rH)

Select High Alarm Max using the  key and set the required temperature using  and  key.



The Stage 1 Alarm is a time/temperature related alarm. If the maximum threshold is exceeded, a timer is initiated, and no further action is taken at this time.

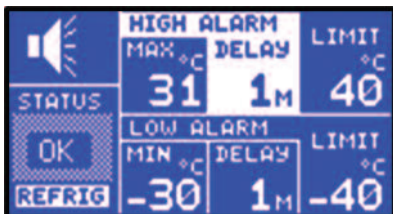

## High Alarm Stage Delay (1-99 min.)

Select High Alarm Delay using the  key and set the required time using  and  key.



After the maximum threshold has been exceeded, the alarm will not be triggered until the timer exceeds the time delay set here. If the temperature drops below the threshold before the expiry of this delay, the timer is reset. If following this, the temperature rises above the threshold again, the timer restarts from zero.

## High Alarm Limit Stage 2 temperature (-99°C to +150°C)/Humidity (0%rH to 100%rH)

Select High Alarm Limit using the  key and set the required temperature using  and  key.



If at any time this limit is exceeded, the time delays will be overridden and the alarm will trigger immediately.

# THX-CDL Operation

## Low Alarm

All the functions described for the high alarm also apply to the low alarm.

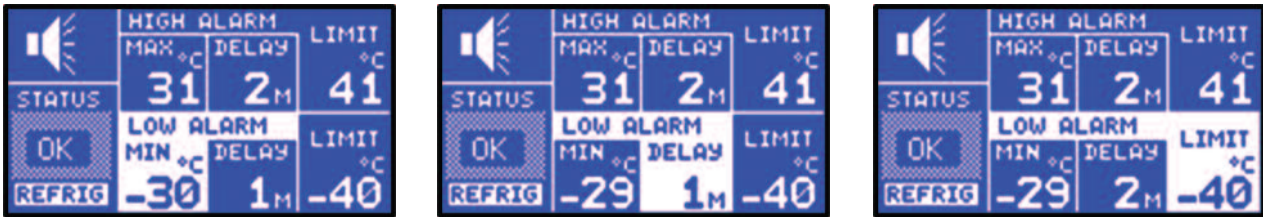

## Cycle Indication

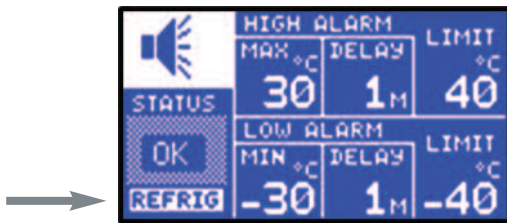

This section of the status window is dedicated to the indication of which cycle is presently active, i.e. REFRIG (Refrigeration cycle), DEFST (Defrost cycle), and DWELL.

## 4.1 Diagnostic Screen

To enter the Diagnostic Screen press the  key twice from the Main Screen.



This screen is continuously refreshed displaying the current state of the system.

The right margin of the screen displays the message 'OK' in front of each of the system's units if that unit is in good working condition.

- The INPUT TYPE window shows which type of sensor is being used.
- The ROOM, EVAPORATOR and PRODUCT sensor calibration data is shown there, respectively. This information is for factory use and fault finding only.
- High Alarm monitor: This display shows the current state of the high alarm monitor, as well as the history. If there is a stage 1 delay timer in progress, this will show the time elapsed since the stage 1 maximum threshold was exceeded. If the alarm has already been triggered, it will show the time elapsed since it has been triggered. If the high alarm monitor is at rest, it will show the alarm history, i.e. the last time it was triggered.
- Low Alarm monitor: This display shows the current state of the low alarm monitor, as well as the history, similar to above.
- Mains-Fail Monitor: This display shows the current state of the mains-fail monitor, as well as the history. If there is a mains-fail in progress, it will show the time elapsed since the mains failed. If the mains supply is present, then the mains-fail history is displayed.

# THX-CDL Operation

## 4.2 Diagnostic Screen 2

To enter the Diagnostic Screen 2 press the  key twice from the Main Screen.

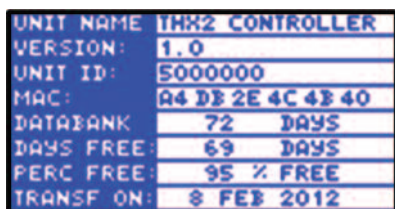



- UNIT NAME shows the name of the unit
- VERSION, this is the software version installed on the unit
- UNIT ID, this is the unit serial number
- MAC, this is the unique electronic signature of the unit
- The DATABANK window shows the capacity of the internal databank
- The DAYS FREE window shows the total number of days which have not yet been 'used'
- The PERC FREE window shows the percentage of the databank which has not yet been 'used'
- The TRANSF ON window shows the date on which the contents of the internal databank need to be transferred.

## 5.0 PLOT SCREEN

To enter the Plot Screen press the  key from the Main Screen.



This screen displays the plot of the temperature / humidity readings logged for the current day.

The user can select any sensor using the  and  keys. The user can read sample information using the  and  keys.

# THX-CDL Operation



## 5.1 History

To enter the History press the  key twice from the Main Screen.





Select the year, month and day using the  and  keys and press the  key.

Functions that are available from this screen are as follows:

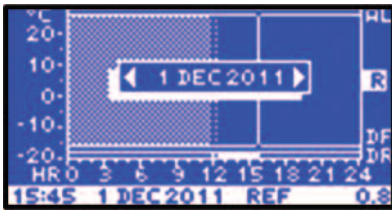
- By pressing the  key, the values of the previous day will be displayed.
- By pressing the  key, the unit will increment through the values, according to the sample period. At the end of each day, the next day logged in the databank will be displayed.
- By pressing the  key, user can select the date



Use the   keys to select the date and press the  key to confirm.

# USB

THX Controller can transfer data to/from a USB memory stick. The user can download the logged data and the unit settings to any USB memory device in FAT 32 format.

The USB memory key can also be used to load new unit settings; this is useful, for example, for importing the settings from a previously configured unit.

To enter to the USB menu, connect the USB stick to USB port when the Sensor Summary Screen is displayed.



## 1. Download Data

From the USB Menu screen, press key to reveal the Download Data Screen.

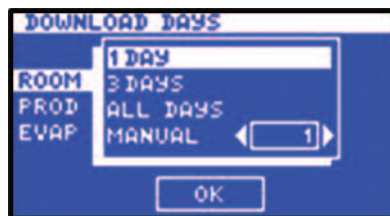

Use the or key to select the required channel and then confirm the selection using the key.

Choose the sample period from the pop-up menu using the or key and then confirm the selection using the key.

Choose another channel or select OK and confirm using the key. The download bar will appear indicate the downloading progress.

Do not remove the memory stick until the progress bar disappears. The data is saved to a file in '.csv' format, compatible with Microsoft® Excel. The file name is automatically generated by the Data Logger.

## 2. Download Setup

From the Main Screen, press the key, followed by the key to select Download Setup in the menu and then confirm selection

using the key to start download the settings. Do not remove the memory stick until the progress bar disappears.

The data is saved to a file in 'setup.txt' format.

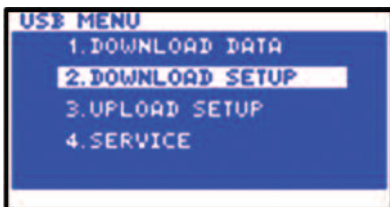

## 3. Upload Setup

From the Main Screen, press the key, followed by the key to select Upload Setup in the menu and then confirm selection

using the key to start upload previously downloaded settings from the memory stick. Do not remove the memory stick until the progress bar disappears.

## 4. Service

For use only by authorised personnel and trained installers.

# Web Server

To connect with unit's embedded Web Server, connect unit to the network (switch, hub, router etc.) using Ethernet CAT-5 cable or directly to the network adapter on your computer and open a web browser - Windows Internet Explorer (version 8.0 or higher) or Firefox. Input the unit's IP address (default -192.168.0.2).



Network connection

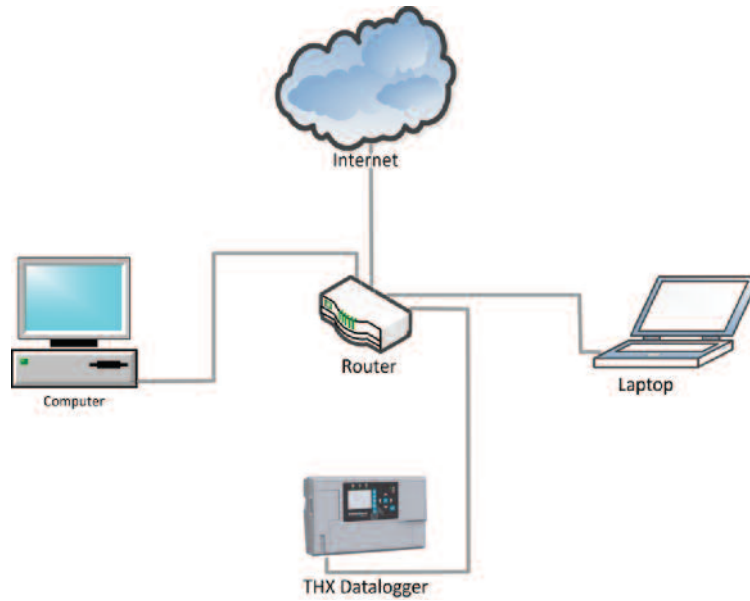

Direct connection

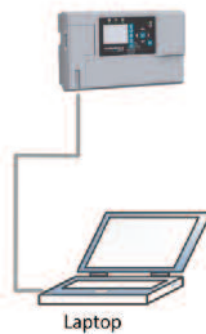

Enter the username and password (as provided below).

Default username and password:

User: user

Password: password



# Web Server

## 1. Live Data

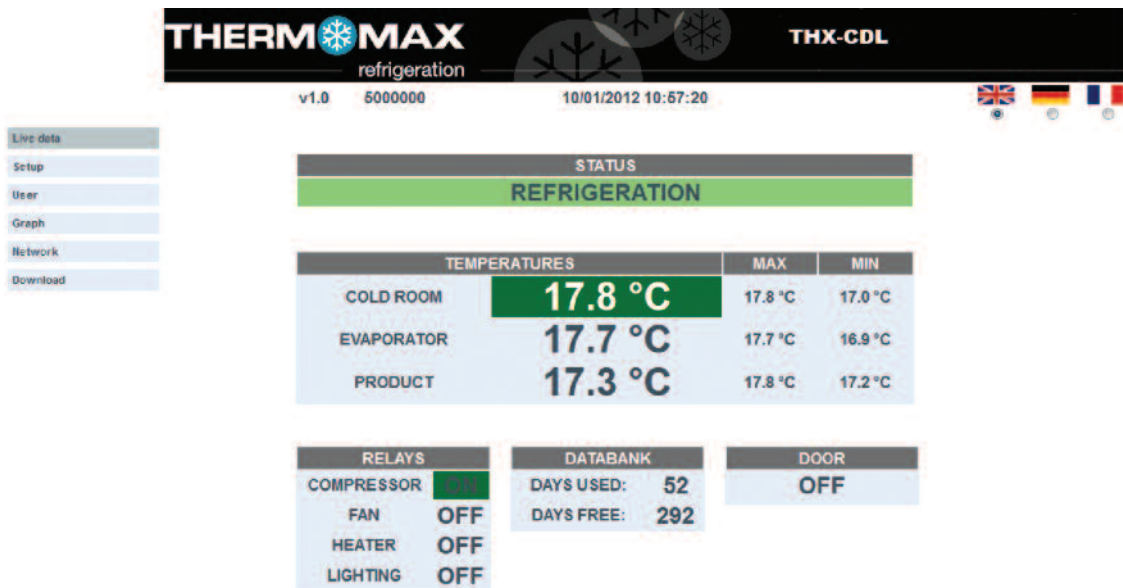

**THERMO**MAX refrigeration **THX-CDL**

v1.0 5000000 10/01/2012 10:57:20

UK Germany France

- Live data
- Setup
- User
- Graph
- Network
- Download

**STATUS**  
**REFRIGERATION**

TEMPERATURES		MAX	MIN
COLD ROOM	<b>17.8 °C</b>	17.8 °C	17.0 °C
EVAPORATOR	<b>17.7 °C</b>	17.7 °C	16.9 °C
PRODUCT	<b>17.3 °C</b>	17.8 °C	17.2 °C

RELAYS	
COMPRESSOR	<b>ON</b>
FAN	OFF
HEATER	OFF
LIGHTING	OFF

DATABANK	
DAYS USED:	<b>52</b>
DAYS FREE:	<b>292</b>

DOOR	
<b>OFF</b>	

Live data screen displays the current unit and relays status, firmware version, ID, databank status and temperature readings. The screen is refreshing every 10 seconds.

To change the language, click on the suitable flag as outlined below.



# Web Server

## 2. Setup

The screenshot displays the web server interface for THERMOMAX refrigeration (THX-CDL). The interface is organized into several functional sections, each with its own settings and a 'Set' button to save changes. A sidebar on the left provides navigation options: Live data, Setup (selected), User, Graph, Network, and Download. The main content area includes:

- COMPRESSOR:** Coldroom temp set (16 °C), Thermostat hysteresis (1 °C), and Switch delay (1 min).
- FAN:** Selection between RUN and STOP, Stop temp (10 °C), and Delay (1 min).
- ENERGY SAVING:** Coldroom temp set (-5 °C), Duration (1 HR), Start time (00:00), and day selection (Mo, Tu, We, Th, Fr, Sa, Su).
- DEFROST:** Selection between Electr and Hot gas, Duration (1 min), Termination (10 °C), Dwell (1 min), and a detailed schedule grid for days 1 through 12.
- ALARM:** Alarm HI (Limit: 25 °C, Max: 30 °C, Delay: 1 min) and Alarm LO (Limit: -40 °C, Min: 30 °C, Delay: 1 min).
- DATABANK:** Sample period selection (1 min, 5 min, 15 min, 30 min, 60 min).
- TIME:** Current time and date selection (01:00, 01/01/2012).
- FACTORY SETTINGS:** A red 'Set' button to restore factory defaults.

Setup screen display settings and allows user to edit them.

- Compressor (enter required coldroom temperature, thermostat hysteresis, switch delay and click **Set** to save)
- FAN (set fan to RUN or STOP and enter Stop Temp., Delay and click **Set** to save)
- Energy Saving (enter required coldroom temp., set the schedule and click **Set** to save)
- Defrost (choose the defrost type and set the schedule, click **Set** to save)
- Alarm (set the HI and LO alarm settings, click **Set** to save)
- Databank (choose the sample period and click **Set** to save)
- Time (set the current time and click **Set** to save)
- Factory Settings (click **Set** and confirm to restore the factory settings)

## Web Server

### 3. User

User screen allows user to change the username and password.

To change the password enter old username and password, then enter new username and password, confirm password and click the **Set** button.

### 4. Graph

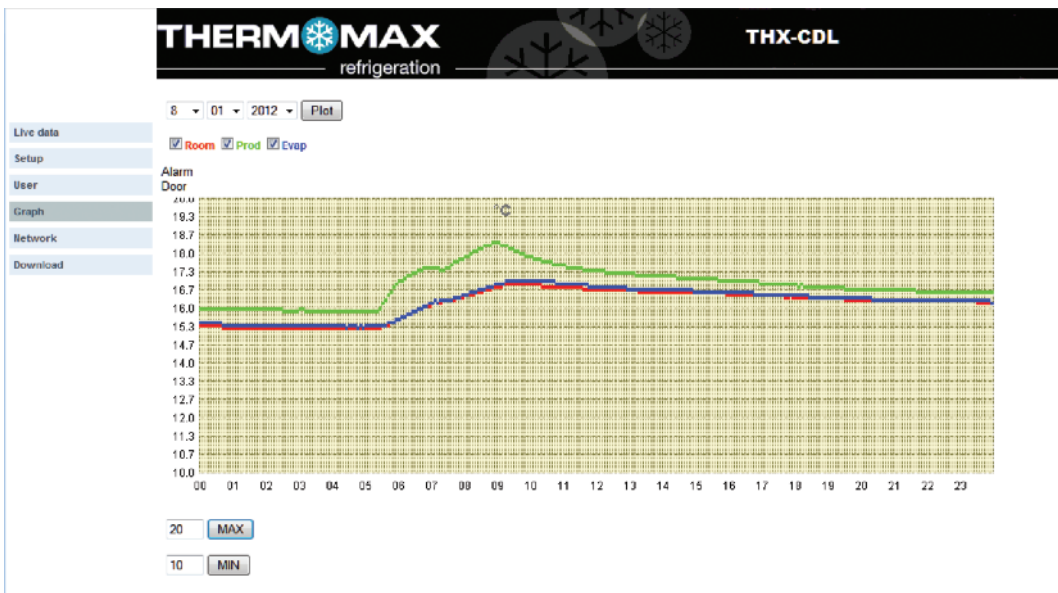

Graph screen allows user to generate multiple channel graph.

To generate the graph, set the date **23/08/2011**, choose the channels  **Room**  **Prod**  **Evap** and click on the **Plot** button.

User can set the graph scale using **20 MAX** **10 MIN** buttons.

*Note: Java JRE 6 or higher required.*

# Web Server

## 5. Network

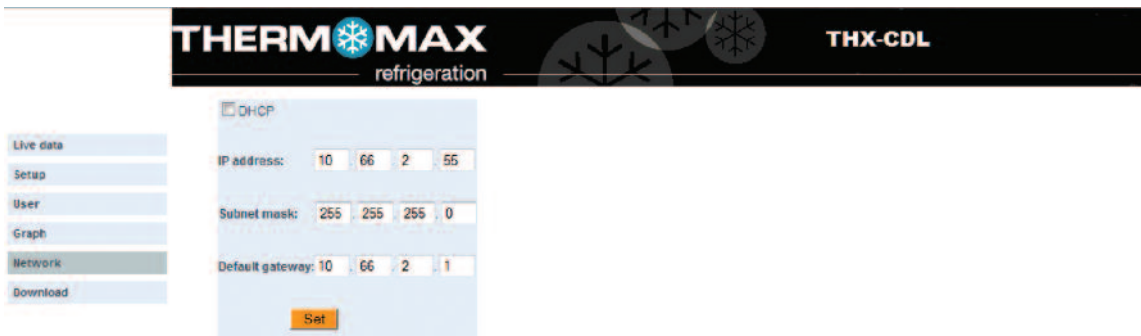

Network screen display network setting for the unit and allow user to change them.

Please enter your network details or choose DHCP for Automatic Network Configuration.

To set Automatic Network Configuration, click on the  DHCP and click the  button to save.

DHCP Indicates that the DHCP is OFF.

DHCP Indicates that the DHCP is ON.

## 6. Download



Set the required time period   or tick  ALL DAYS , choose the channel and click  to download.

Click  to save the data on hard drive.

*Note: Java JRE 6 or higher required.*

# Specification

## ELECTRICAL

<b>Supply Voltage:</b>	110-240V AC Single Phase
<b>Fuses:</b>	1A 20mm Slow Blow
<b>Relay Outputs:</b>	Alarm: 5A changeover 2 pin isolated – (volt free contacts)  Fan Relay: 10A single pole  Heater Relay: 13A single pole  Compressor Relay: 13A single pole  Light Relay: 5A single pole
<b>Ambient Temperature:</b>	0°C to +40°C

## MECHANICAL:

<b>Dimensions:</b>	width: 300mm height: 100mm depth: 180mm weight: 1.5kg sensor: (each) 0.13kg
<b>Box Material:</b>	Plastic
<b>Display:</b>	Large LCD with backlight

## SENSORS:

<b>Type:</b>	SX™ PT 100 Platinum Film
<b>Compensation:</b>	3 wire compensated
<b>Cable Length:</b>	A variety of lengths are available from 5m to 50m
<b>Battery:</b>	3.7V Lithium polymer 1000mAh with built-in protection

## ACCESSORIES:

- Sensor (5m Cable)
- Sensor (15m Cable)
- Sensor (25m Cable)
- Sensor Extender 10, 50m
- Humidity Sensor
- Panel Mount Kit
- Wall Bracket for Humidity Sensor





WALL MOUNT TEMPLATE





**Kingspan Environmental**

180 Gilford Road, Portadown, Co. Armagh,  
Northern Ireland BT63 5LF

**Sales Support Office:** +44 (0) 28 3836 4444

**Email:** [info@thermomax-refrigeration.com](mailto:info@thermomax-refrigeration.com)

**[www.thermomax-refrigeration.com](http://www.thermomax-refrigeration.com)**

*Part of*



In keeping with Company policy of continuing research and development and in order to offer our clients the most advanced products, Kingspan Environmental reserves the right to alter specifications and drawings without prior notice.

Issue No. 1: April 2012