

THERMOMAX

SM QUATTRO

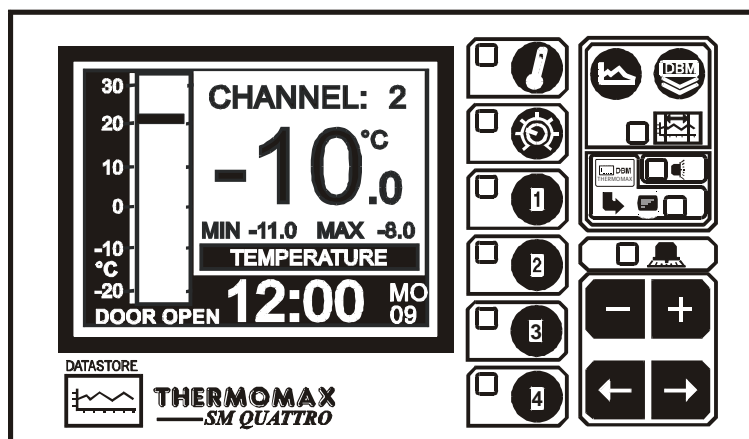







4 - CHANNEL DATALOGGER AND ALARM

ENGLISH



www.Thermomax-Group.com

CONTENTS

SECTION 1 - INTRODUCTION	2
SECTION 2 - INSTALLATION	3
2.1 - SM QUATTRO Unit	4
2.2 - Sensors	4
2.3 - Alarm Relay	5
2.4 - Power Connections and Wiring Diagram	5
2.5 - Battery	5
SECTION 3 - OPERATION	6
3.1 - DESCRIPTION	6
3.2 - MAIN SCREENS: 	
3.2.1 MAIN SCREEN 1: Bar Graph Temperature / Humidity Display	8
3.2.2 MAIN SCREEN 2: Digital Temperature / Humidity Display	9
3.3 - SET SCREENS: 	
3.3.1 SET SCREEN 1: Clock / Calendar	10
3.3.2 SET SCREEN 2: System Presets 1	11
3.3.3 SET SCREEN 3: System Presets 2.....	13
3.3.4 SET SCREEN 4: Sensor Input Type Selection	14
3.4 - SYSTEM DIAGNOSTICS: 	
3.4.1 DATABANK DIAGNOSTICS SCREEN	15
3.4.2 CHANNEL DIAGNOSTICS SCREEN	16
3.4.3 CALIBRATION TRIMMING SCREEN	17
3.5 - CHANNEL SCREENS:  	
3.5.1 CHANNEL DISPLAY SCREENS	18
3.5.2 CHANNEL SET SCREEN - TEMPERATURE	19
3.5.3 CHANNEL SET SCREEN - HUMIDITY	20
3.6 - CURRENT DAY PLOT: 	21
3.7 - PLOT HISTORY: Data log of previous days: 	22
3.8 - DATA TRANSFER: 	24
3.8.1 Transferring Data Using the Masterlink software	24
3.8.2 Transferring Data to the Masterlink Hardware	24
3.8.3 Printing Data to the Thermomax Serial Printer	26
3.9 - DATA TRANSFER - Panelmount units Only	27
SECTION 4 - FAULT FINDING	31
SECTION 5 - SPECIFICATIONS	32
KEYPAD LOCK	33
SM QUATTRO PANELMOUNT	34
DEUTSCHE BEDIENUNGSANLEITUNG	36

SECTION 1 INTRODUCTION

The SM QUATTRO microprocessor-based datalogger uses the novel approach of a paperless logging and filing system, which allows the data of any day in its history to be read and examined with a few key presses.

The large graphics LCD display communicates the information to the user with clarity, making programming and setting up friendly and uncomplicated, without compromising its sophistication and digital accuracy.

SUMMARY OF FEATURES

DATALOGGER

- Paperless datalogger with automatic filing by date
- 50-year clock/calendar for datalogger filing.
- The temperature from each Channel is sampled every 15 minutes and stored to an internal databank.
- 'Percentage of internal databank used' indication in bargraph and digital form.
- Power Supply 220 – 240V AC Mains.
- Contents of internal databank can be transferred directly to the PC using the MASTERLINK Software or via a MASTERLINK Hardware module to a PC at a remote site.

ALARM

- 2-Stage high and low level alarms with mute and reset facilities,
- Stage 1 temperature threshold with trigger delay.
- Stage 2 limit temperature with immediate trigger.
- Status window for system fault indication.
- Diagnostics screen revealing system parameters.
- Alarm history record for low alarm, high alarm and power fail.
- Battery back-up for power-fail operation.

Note: The information supplied in this manual is for guidance only – no part of this may be used for any agreement, whether express or implied, or to form any contract.

SECTION 2 INSTALLATION

Note: This installation procedure is for guidance only, and its suitability should be verified by the installer.

SAFETY PRECAUTIONS

The following safety precautions are strongly recommended:

- 1 Before attempting to install and operate the unit, read this instruction manual carefully.
- 2 Installation and any maintenance required should only be carried out by suitably qualified personnel.
- 3 It is recommended that the unit be connected to the mains supply via a suitably rated isolating switch.
- 4 **WARNING: When the unit is connected to the mains supply and the cover is opened, the circuits at mains voltage will be exposed.** Therefore when installing the unit, ensure all required connections (including battery connection, if included), are made and covers replaced before turning on the mains supply. Ensure that all the connections made are secure. If any maintenance work e.g. installing a new battery, is required ensure that the unit is isolated from the mains supply before removing the cover. **Never leave the unit unattended if the cover has been removed and the mains supply is connected.**
- 5 Do not exceed unit ratings as shown on the ratings label.
- 6 It is advisable to route mains cables away from low voltage or sensor cables.

2.1 SM QUATTRO UNIT

NOTE: For viewing comfort, the SM QUATTRO unit should be positioned at eye level. It is always good practice to keep electronic equipment away from cold, heat and electrical plant, as extremes of temperature may reduce the lifetime of the device, and heavy electrical loads, switches, relays or contactors too close to the device may cause electrical and electro-magnetic interference when switched on or off.

- 2.1.1 Knock out the entries into the moulding to be used for connection, either behind or under the moulding, whichever is suitable for the particular installation.
- 2.1.2 Fasten the screw corresponding to the top centre lug on the back of the SM QUATTRO moulding, into the wall or panel on which the unit is to be mounted. Leave a gap of approximately 3mm between the screw head and the wall. Position the moulding and slot in the lug over the screw.
- 2.1.3 Level the SM QUATTRO moulding and, if using rear entry, mark the entry holes in the panel behind the appropriate knock-out entries, as well as the two lower mounting holes. Remove the moulding, drill the necessary holes in the panel, assemble any grommets or conduit adapters if used, replace the moulding and fasten using the two lower screws.

2.2 SENSORS

The *SM QUATTRO* may be used with a variety of sensors of different cable lengths. If required, sensors are available with extended cable lengths or alternatively, sensor extenders are available, also in a variety of lengths. If the sensors need to be extended, but factory-made extenders are not available, they can be extended using a suitable 4 core or 3 core cable, according to the diagram shown below.



Please note however, that as with all PT100 sensor applications, a good connection is vital. It is therefore recommended that wherever there is any doubt, a factory- extended sensor or sensor extender should be used.

2.3 ALARM RELAY

NOTE: The alarm relay is a 3 contact changeover arrangement which is isolated (volt-free). This relay is normally energised, and switches off when the alarm is triggered, or in the case of power failure. It may be used to trigger an external bell, warning lamp, or digital communicator (telephone dialler).

If an external device is used, connect the alarm as appropriate, according to the diagram in the next section.

2.4 POWER CONNECTIONS AND WIRING DIAGRAM

NOTE: This device should be properly earthed. Flexible wires simplify connection to the terminals. All connections should be secure and adequately tightened. It is good practice to keep mains cables away from sensor cables and other low voltage signal cables.

Connect the supply to the unit, as per diagram below, using the appropriate input voltage according to the application.

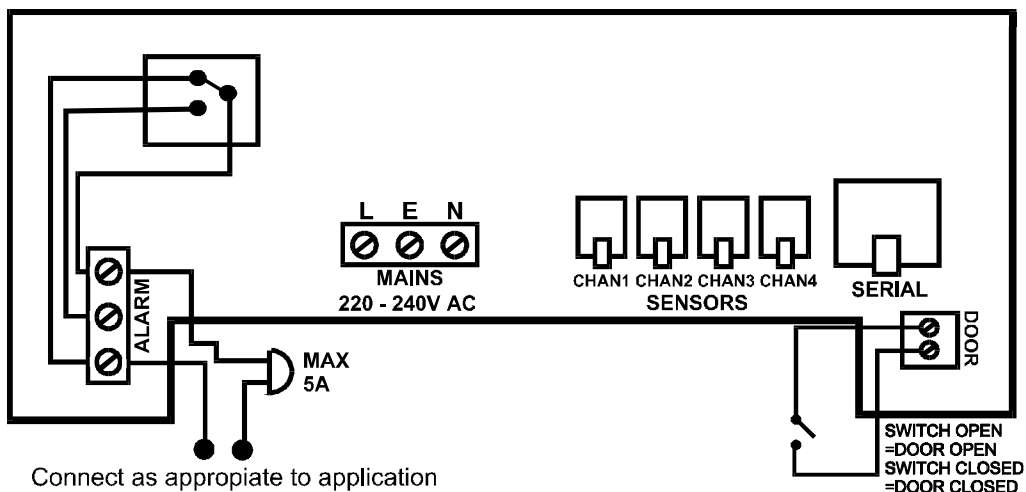

2.5 BATTERY

The battery supplied is a 9V PP3 nickel metal hydride rechargeable battery and is attached to the lid of the terminal compartment, but not plugged in. This should be plugged in after installation. This battery is not essential for the system operation, but is used in the case of power failure, thereby continuing to log the four input temperatures for 3 – 4 hours, and maintaining the system clock.

If the power cut takes longer and the battery is discharged, the clock must be set when the power supply is re-established. The system parameters remain intact.

It is recommended that the battery is changed every 12 months, in order to maintain good power failure operation. When replacing, ensure that the type of battery used is as specified.

SECTION 3 SM QUATTRO OPERATION

In order to fully understand the operation of the *SM QUATTRO*, this section should be read carefully.

3.1 DESCRIPTION

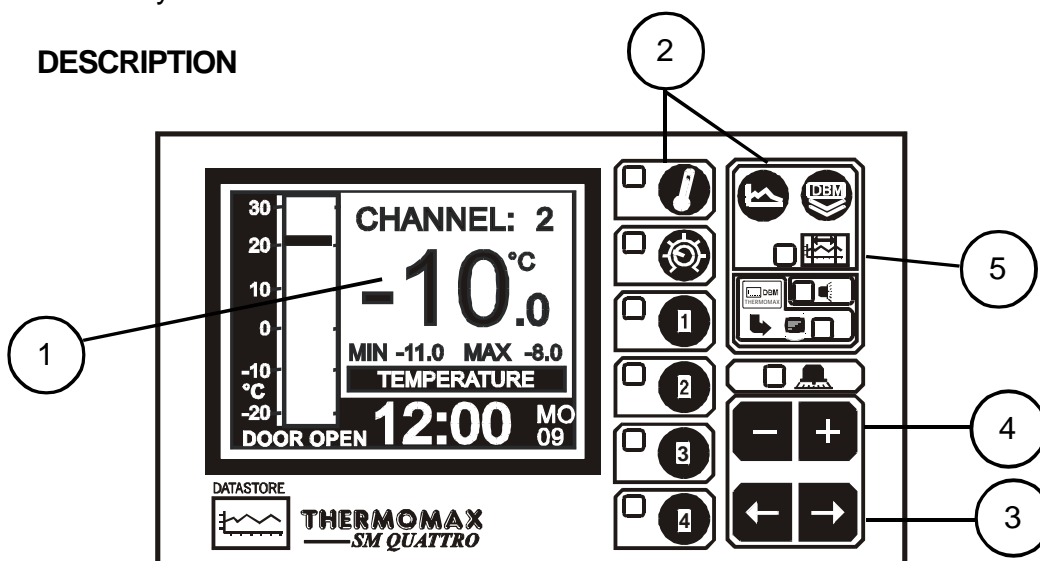

1 GRAPHICS LCD DISPLAY



Displays all the information. The contrast is adjustable to suit the user. (See 3.2.1 Main Screen 1).

2 FUNCTION KEYS

There are eight function keys on the SM QUATTRO datalogger:

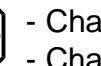
 - Main Screen 1
 - Main Screen 2

 - Channel 1 Display Screen
 - Channel 1 Set Screen

 - Set Screen 1
 - Set Screen 2
 - Set Screen 3
 - Set Screen 4

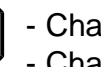
 - Channel 2 Display Screen
 - Channel 2 Set Screen

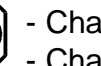

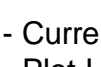
 - Channel 3 Display Screen
 - Channel 3 Set Screen

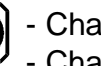
 - Current Day Plot
 - Plot History Screen

 - Channel 4 Display Screen
 - Channel 4 Set Screen

 - Data Transfer Key

3 SELECT KEYS

Within each function, there are some parameters that can be selected for setting or displaying purposes. The   keys allow the required parameter to be chosen, without changing any of its properties.

4 SET KEYS

The **+** and **-** keys are used to set the value of any selected parameter, by increasing and decreasing the value respectively.

In most of the functions, described later in the manual, the **+** and **-** keys have an auto-repeat facility: press and hold the key in order to advance quickly.

Note: The **+** and **-** keys are the only keys which can alter the value of a selected parameter. Other keys may be pressed to view or select these parameters without effecting any change in the system.

5 INDICATORS

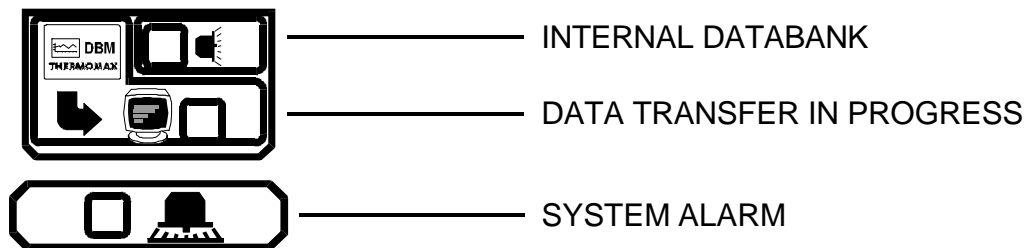



The System Alarm can be triggered by the high temperature alarm, low temperature alarm, or by a sensor fault.

3.2 MAIN SCREENS

3.2.1 MAIN SCREEN 1: BAR GRAPH TEMPERATURE / HUMIDITY DISPLAY

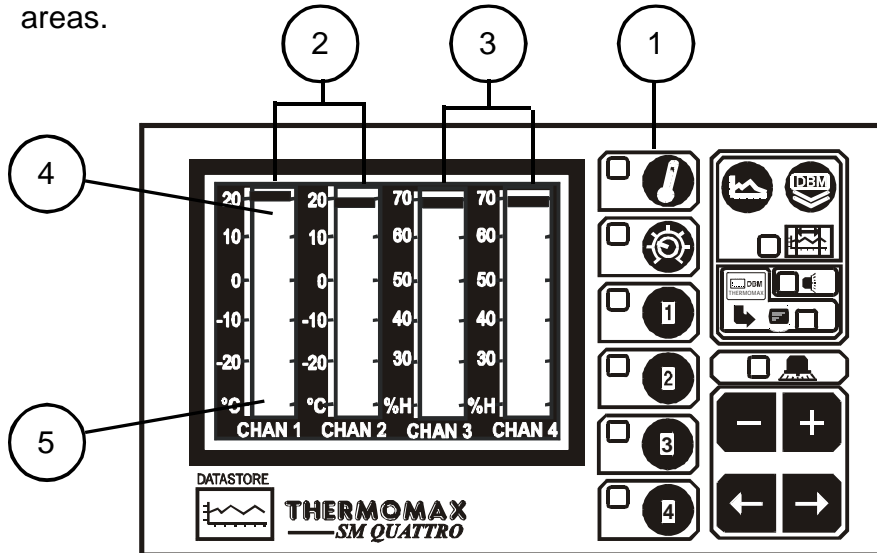
This screen allows the user to view the information for each channel in bargraph form and is shown below. The high and low Temperature / Humidity limits are shown on these bargraphs and are represented by the shaded areas.



Pressing the  key the first time will display the MAIN SCREEN which shows a four channel bargraph display as shown above.

- 2 Channels 1 & 2 in this example display temperature.
- 3 Channels 3 & 4 display relative humidity in this example.
- 4 This shaded area shows the High Alarm Limits (Stage 2 Alarm).
- 5 This shaded area shows the Low Alarm Limits (Stage 2 Alarm).

Note 1:



In this example configuration, channels 1 & 2 are connected to temperature sensors and channels 3 & 4 are connected to humidity sensors, therefore the bargraph for channels 3 & 4 displays relative humidity (%H). (See section 3.3.4).

Note 2:

See Section 3.5.2 "Channel Set Screens" for more information on temperature Alarms, and section 3.5.3 for information on Humidity Alarms.

Note 3:

The display contrast may be adjusted in this screen.

Press  to increase and  to decrease the contrast. To adjust quickly, press and hold for auto-repeat.

3.2.2 MAIN SCREEN 2: DIGITAL TEMPERATURE / HUMIDITY DISPLAY

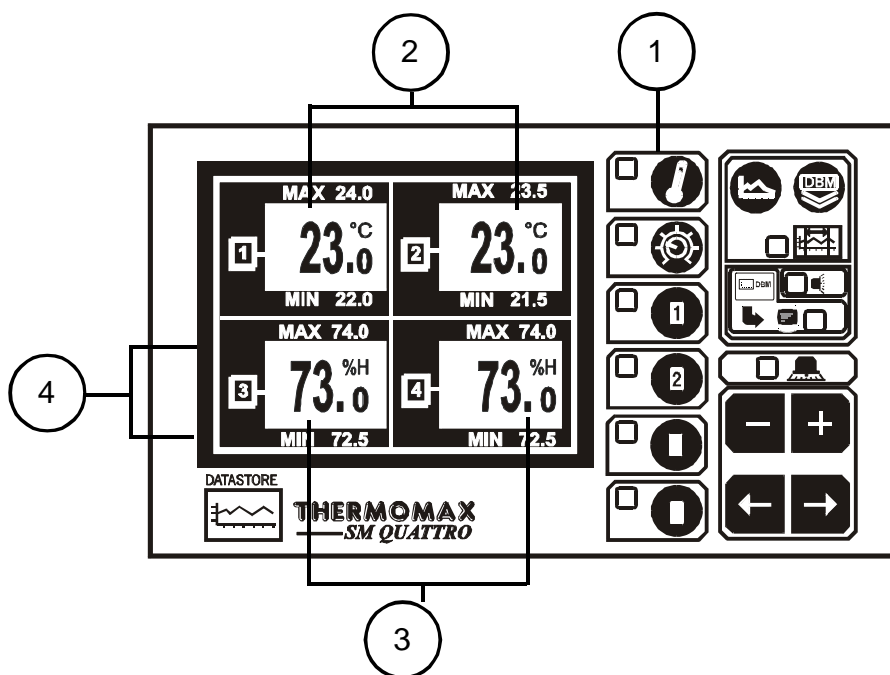

1 MAIN SCREEN function selector.

Pressing the  key a second time reveals the screen above.

2 Current temperature for channels 1 & 2.

3 Current humidity reading for channels 3 & 4.

4 Maximum and minimum daily temperature / humidity readings for each channel.

Note: The display contrast may be adjusted in this screen.

Press  to increase and  to decrease the contrast.
To adjust quickly, press and hold for auto-repeat.

3.3 SET SCREENS

3.3.1 SET SCREEN 1 : CLOCK / CALENDAR

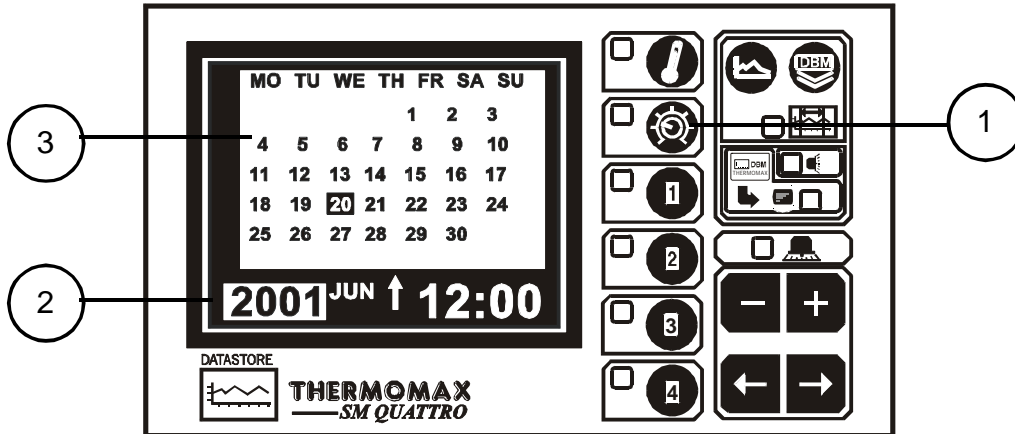

1 SET SCREEN function selector

The datalogging system uses the calendar to file the logged data.

2 Selection indicator

The highlighted parameter is adjusted by pressing the **+** or **-** key. (The selections are: 'year', 'month', 'day', '↑', 'hour' and 'minutes'.) The '↑' indicates that the day on the calendar above is being set. The clock is in 24-hour format.

To advance quickly, press and hold the **+** or **-** key for auto repeat.

3 Calendar

This is the calendar of the month selected, with day of the week indication.

SETTING THE DATE AND TIME:

Step 1 : Use the **- +** keys to set the current 'Year'.

Step 2: Use the **→** key to move to the 'Month' option and then use the **- +** keys to set the current month.

Step 3: Repeat step 2 to set the current 'date' and 'time' ('minutes' and 'hours') in turn.



5 Keypad Lock

The keypad may be locked or unlocked when this window is selected. See page 27 at the end of this manual.

6 Piezo and Indicator test

By pressing the  key when the TEST window is selected, the SM QUATTRO's internal audible alarm will 'sound' and all indicators will illuminate.

7 Door Switch Selection



The SM QUATTRO provides the option to connect a door switch for monitoring purposes (the status of the door is displayed and logged in graphical form, see section 3.6). This option may be enabled or disabled by pressing the  or  respectively.

Note: See section 2.4 for wiring diagram.

8 Diagnostics

By pressing the  key when the DIAG window is selected, the SM QUATTRO DIAGNOSTICS screen is activated. (see next section 3.4).

9 Language Selection

The language used by the system to communicate the information may be selected here. Use the  and  keys to make your English, French or German selection.

3.3.3 SET SCREEN 3 : SYSTEM PRESETS 2

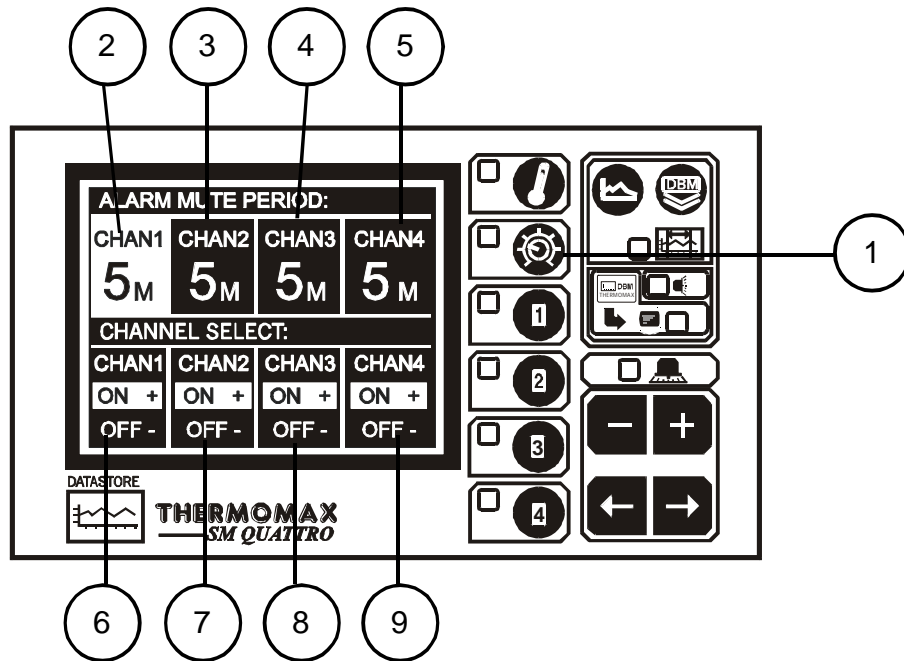

1 SET SCREEN function selector

Pressing this key a third time reveals Set Screen 3.

2 Alarm Mute

Alarm mute period for Channel 1 (from 0 to 95 Minutes). If any key is pressed during an Alarm situation for this channel, the buzzer will be muted (silenced) for this period.

3-5 Alarm Mute period for Channel 2 to Channel 4 (from 0 to 95 Minutes). Same as above.

6 Channel select for Channel 1. Each sensor input can be “switched” on or off by pressing the **+** or **-** keys for 5 seconds respectively. When the sensor input is switched “ON”, the unit will operate in normal mode and the actual sensor temperature will be monitored and logged to the databank every 15 minutes. If the sensor input is switched “OFF”, the unit will display 0°C continuously. This value will also be logged to the databank. Hence it is therefore only necessary to connect sensors to the required number of inputs.

Note: If a channel is switched off, the Alarm parameters will automatically revert back to the default factory settings to prevent an alarm occurrence. These parameters cannot be changed until the sensor input is switched on again.





7-9 Channel Select for channel 2 to channel 4.

3.3.4 SET SCREEN 4: SENSOR INPUT TYPE SELECTION

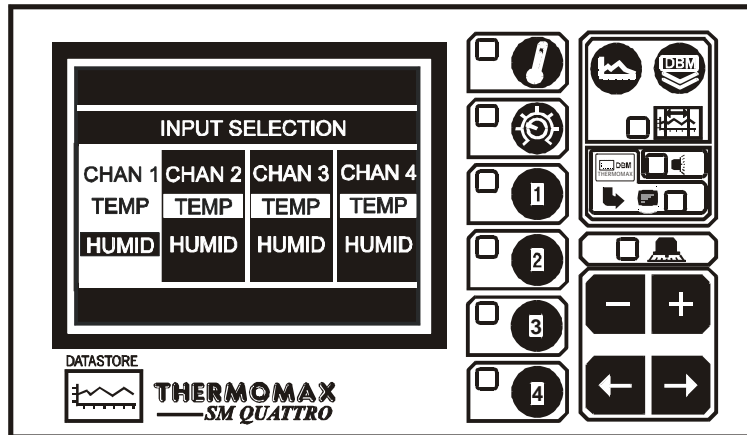
The new SM Quattro now has the ability to measure, display and record Relative Humidity (as a percentage %H) on any of its 4 sensor inputs using the Thermomax Humidity Sensor (CO429). The 4 sensor inputs can be configured to read either Temperature or Relative Humidity. As a factory default, all 4 sensor inputs are configured to accept temperature sensors. The following paragraph describes how to change the configuration for each sensor input if required.

- 1 In order to change the sensor input configuration, press the  key **four** times to reveal the new INPUT SELECTION screen as displayed below. This screen gives you the option to choose the sensor type to be used with each of the four input channels. This can be either the standard PT100 temperature sensor or the Humidity Sensor.



- 2 By using the   keys, you can move to the required channel selection window.
- 3 Pressing the  key, allows you to select the input channel for connection with a humidity sensor for measurement of relative humidity percentage.
- 4 Pressing the  key selects an input for connection with a standard PT100 temperature sensor.

For example, the diagram above shows channels 1 and 2 configured as Temperature inputs and 3 and 4 configured as Humidity inputs.

Note: The information displayed on various screens will vary, depending on the sensor type input as selected above (humidity / temperature).

3.4 SYSTEM DIAGNOSTICS
3.4.1 DATABANK DIAGNOSTICS SCREEN

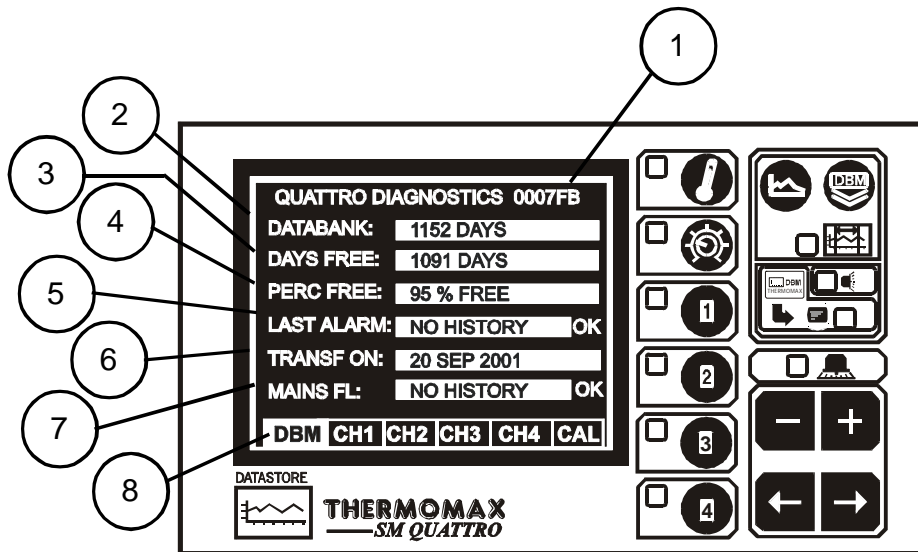

- 1 This is the unique electronic signature of the SM QUATTRO.
- 2 The DATABANK window shows the capacity of the internal databank.
- 3 The DAYS FREE window shows the number of days which have not yet been used.
- 4 The PERC FREE window shows the percentage of the databank which has yet not been used.
- 5 The LAST ALRM window shows the last date on which an alarm condition occurred.
- 6 The TRANSF ON window shows the date on which the contents of the internal databank need to be transferred.
- 7 The MAINS FL window shows the last date on which the power failed. During a power fail situation this window will display the duration, in minutes, of the power failure.
- 8 Diagnostics Screen Selection.

Use the   keys to move between one of four diagnostic screens:

- DBM : Databank Diagnostics Screen (Ref. 3.4.1 above)
- CH1 : Channel 1 Diagnostics Screen (Ref. 3.4.2)
- CH4 : Channel 4 Diagnostics Screen (Ref. 3.4.2)
- CAL : Calibration Trimming Screen (Ref. 3.4.3)

3.4.2 CHANNEL DIAGNOSTICS SCREEN

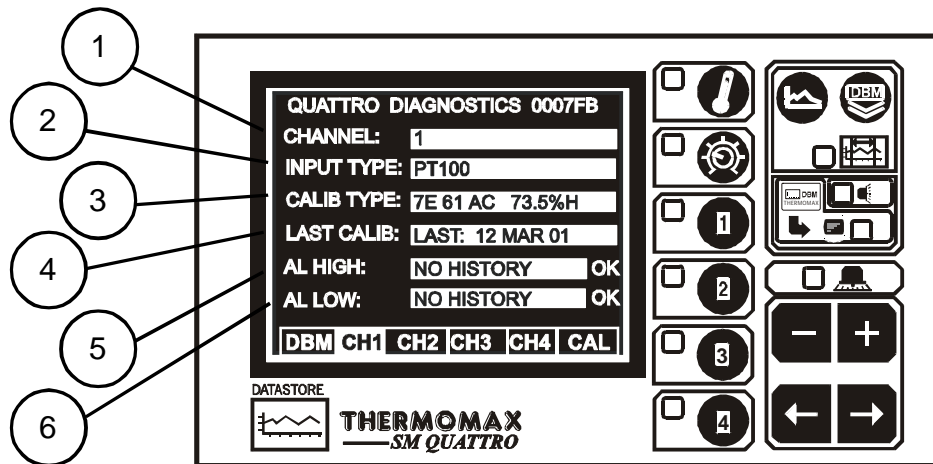

- 1 The CHANNEL window shows the number of the currently selected channel.
- 2 The INPUT TYPE window shows which type of sensor is being used. (PT100 in this case – this is the only type used by the SM QUATTRO at present).
- 3 The CALIB DATA window shows calibration values, for factory use only, and the current temperature reading.
- 4 The LAST CALIB window shows the date when the SM QUATTRO was calibrated.
- 5 The AL HIGH window shows the date when the last high alarm condition occurred for this channel.
- 6 The AL LOW window shows the date when the last low alarm condition occurred for this channel.

3.4.3 CALIBRATION TRIMMING SCREEN

Calibration trimming allows qualified personnel to adjust the SM QUATTRO's calibration by $\pm 2^{\circ}\text{C}$.

Note: A known reference temperature should be used.

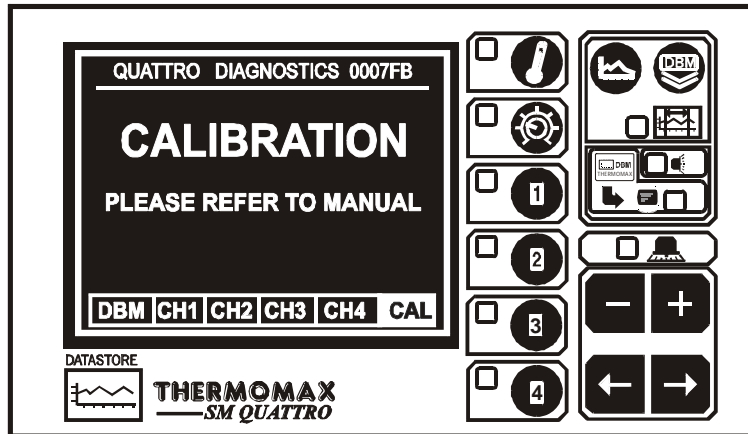

To enter the CALIBRATION TRIMMING Screen, press and hold the **+** key for 5 seconds.

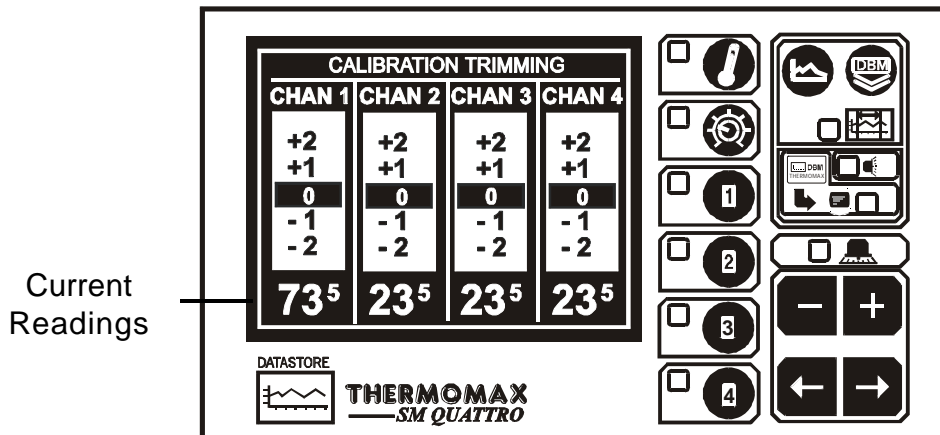

Use the **←** **→** keys to move to the channel which requires calibration trimming. Then use the **+** or **-** keys to adjust the current temperature reading.

3.5 CHANNEL SCREENS
 3.5.1 CHANNEL DISPLAY SCREENS

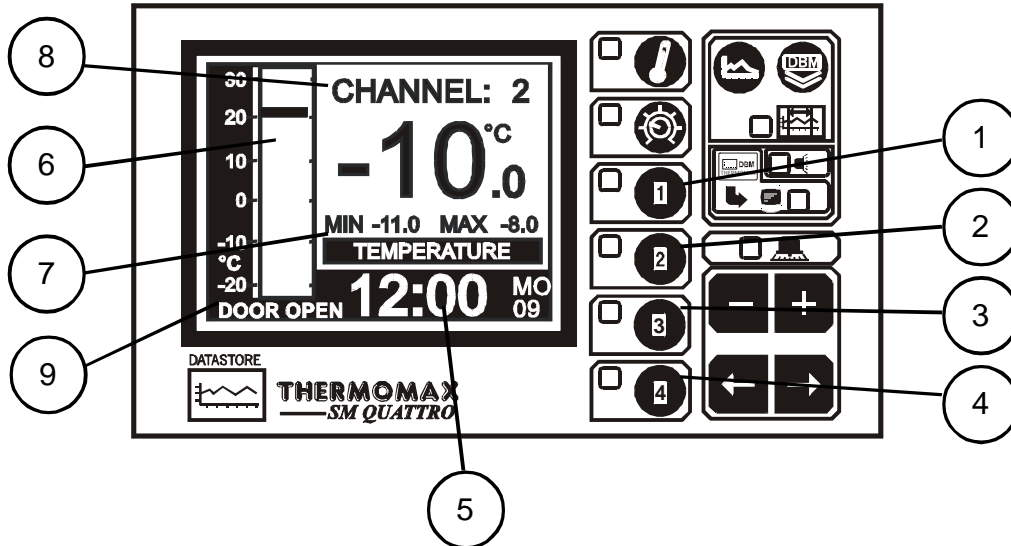

- 1 to 4 CHANNEL 1 to 4 function selector
 Pressing any key of these keys a second time will display the "Channel Set Screen" for that channel.
- 5 Clock display : 24-hour format with day of week abbreviation.
- 6 Temperature bargraph : High and low alarm limits are shown as shaded areas.
- 7 If any channel has been set up to read humidity, **REL HUMIDITY** will be displayed in this area, and all values will be displayed as % relative humidity.
- 8 Digital display of Channel temperature / humidity, with minimum / maximum indication. The minimum and maximum values are daily values, and are reset at midnight.
- 9 When the door switch facility is activated (see 3.3.2) this area will show the status as 'door open' or 'door closed'. Note that if there is no switch connected, the unit will display 'door open'.

Note: The display contrast may also be adjusted from any of these screens by pressing the **+** or **-** keys.

3.5.2 CHANNEL SET SCREENS – TEMPERATURE

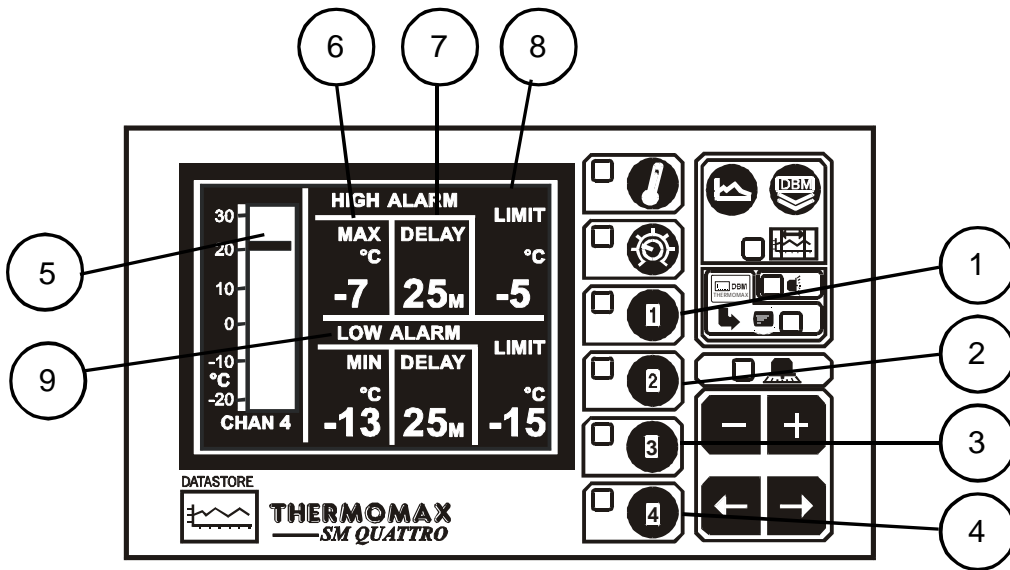

1 to 4 Channel 1 to 4 function selector

Pressing any of these keys a second time will display the “Channel Set Screen” for that channel.

5 Bargraph Display Scale

By pressing the **+** or **-** key, the bargraph display scale may be adjusted to show the temperature range best suited to the particular installation. This scale is also used for the “Plot display” (Ref. 3.6 Current Day Plot and 3.7 Plot History).

6 High Alarm Stage 1 temperature (-50°C to +50°C)

The Stage 1 alarm is a time / temperature related alarm. If the maximum threshold is exceeded, a timer is initiated, and no further action is taken at this time.

7 High Alarm Stage 1 Delay (1 – 99 min.)

After the maximum threshold has been exceeded (Ref. 4 above), the alarm will not be triggered until the timer exceeds the time delay set here. If the temperature drops below the threshold before the expiry of this delay, the timer is reset. If following this the temperature rises above the threshold again, the timer restarts from zero.

8 High Alarm Limit Stage 2 temperature (-50°C to +50°C)

If at any time this limit is exceeded the time delays will be overridden and the alarm will trigger immediately.

9 Low Alarm

All the functions described in 6-8 above also apply to the low alarm.

3.5.3 CHANNEL SET SCREENS – HUMIDITY

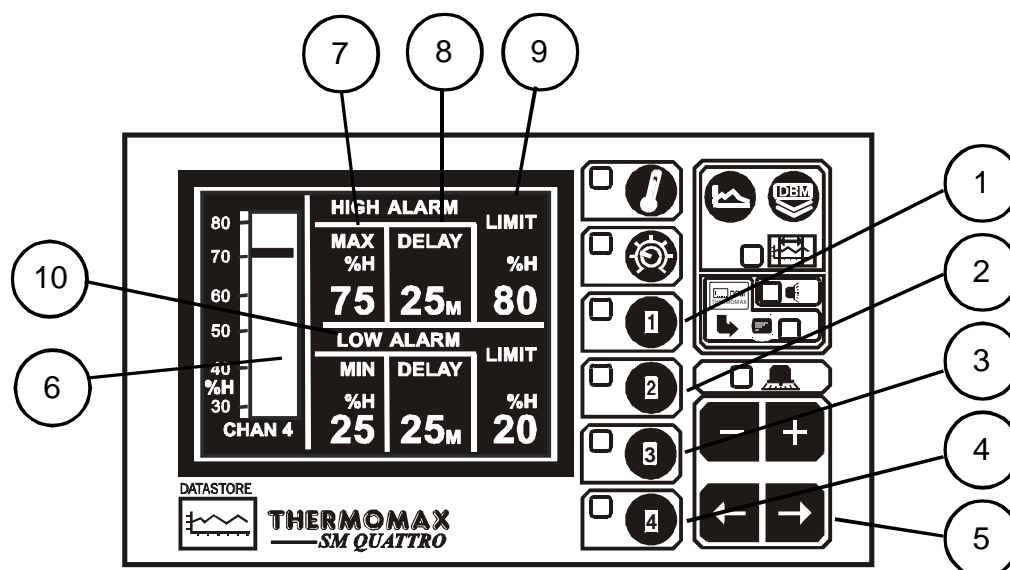

1-4 Channel 1 to 4 function selector

By pressing any of the Channels 1 to 4 function selector keys a second time, the **Channel Set Screen** for that channel will be displayed.

5 By pressing the keys you can select the window you wish to change the information in.

6 Bargraph Display Scale

By pressing the **+** or **-** key, the bargraph scale may be adjusted to show either the temperature or the humidity range best suited to the particular installation. The form of measurement displayed on this bargraph depends on each channel input.

7 High Alarm Stage 1 Humidity (0% to 99.5%)

The stage 1 alarm is a time / humidity related alarm. If the maximum threshold is exceeded, a timer is initiated, and no further action is taken at this time.

8 High Alarm Stage 1 Delay (1 – 99 min.)

After the maximum threshold has been exceeded, the alarm will not be triggered until the time exceeds the time delay set here. If the humidity drops below the threshold before the expiry of this delay, the timer is reset. If following this, the humidity rises above the threshold again, the timer restarts from zero.

9 High Alarm Limit Stage 2 Humidity (0% to 99.5%)

If at any time, this limit is exceeded, the time delays will be overridden and the alarm will trigger immediately.

10 Low Alarm

All the functions described in 7 – 9 above also apply to the Low Alarm.

3.6 CURRENT DAY PLOT

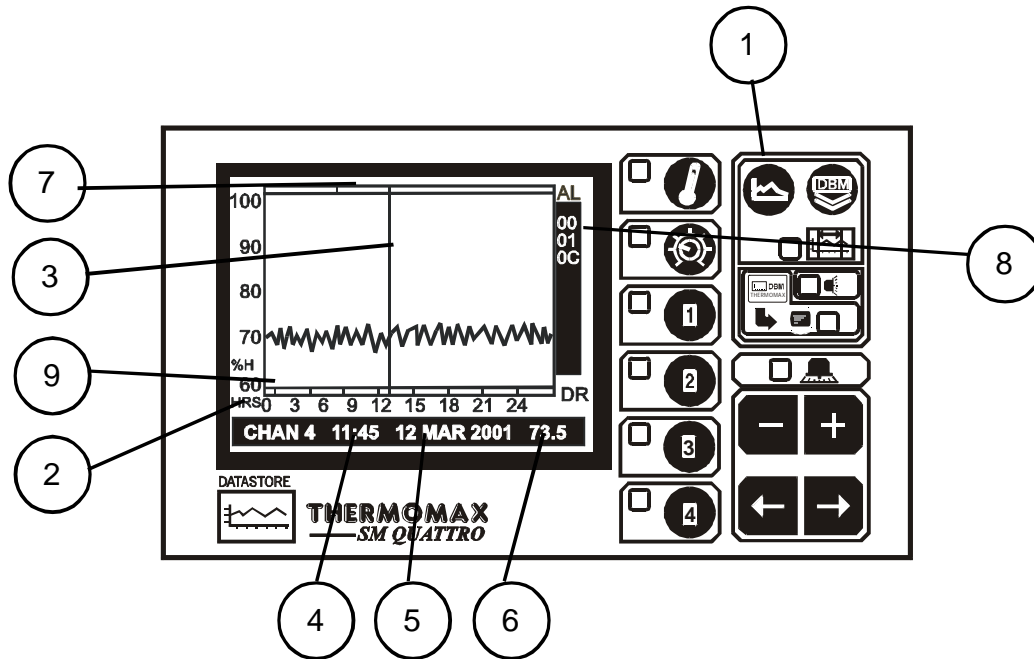

1 CURRENT DAY PLOT SCREEN function selector

Pressing this key displays the plot of the temperatures logged for the current day. When this function has been selected, the plot screen for any of the channels may be selected by pressing one of the channel function selector

keys:  to .

2 **Time of Day:** This is the horizontal axis scale, and represents time.

3 **Current Time-Bar:** The time-bar indicates the current time of day, and therefore the graph following this time bar will be blank.

Samples from earlier in the day may be examined by pressing the  key to move the time-bar to the left. The details relating to the selected time, as shown by the time-bar, are displayed at the bottom of the screen (Ref. 4 – 6) below..

4 **Plot Time:** This displays in digital form, the time indicated by the time-bar.

5 **Plot Date:** This shows the date of the displayed graph.

6 **Time-Bar Temperature:** This displays the logged temperature at the time indicated by the time-bar.

7 **Alarm Log:** Alarm indication to reveal the incidence of an alarm and the time it occurred. It combines indications of a high alarm trigger, low alarm trigger, or power fail.

8 **Unique electronic serial number of SM QUATTRO.**

9 **Door Status Log.** If a door switch has been connected to the coldroom, this area of the display is used to reveal the incidence of a door open. (See Section 3.3.2 “System Pre-sets” which reveals how to enable or disable this function).

Note: Press the MAIN function key  to exit the plot screen.

3.7 PLOT HISTORY : DATA LOG OF PREVIOUS DAYS

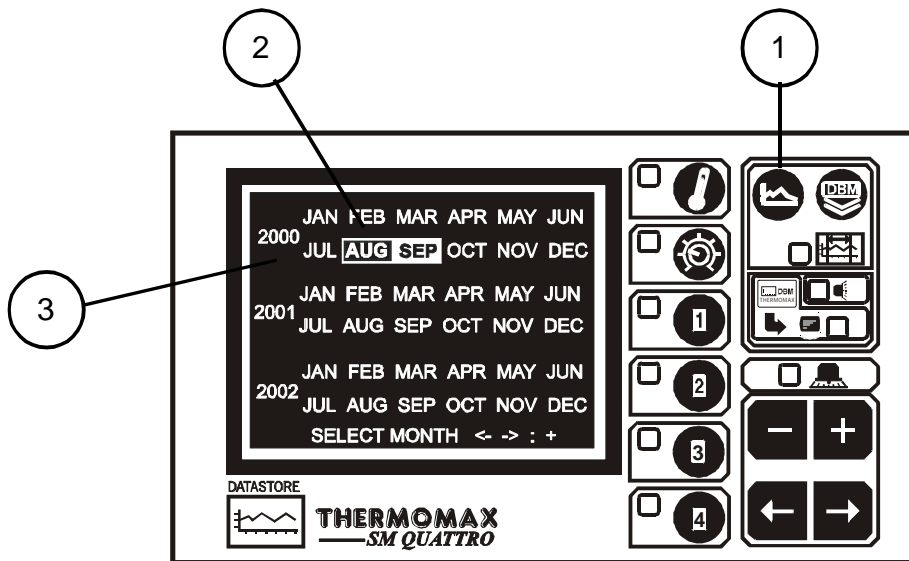

1 Plot History function selector

When this key is pressed twice, the directory of the contents of the internal databank is displayed, as above.

2 The highlighted months on this screen are the months for which the databank contains data.



3 Current Selection

To view the plot of a particular day, select the required month from the calendar using the keys, followed by the key to accept the selection.

A second screen appears for the selection of the day, after which the logged data for the required day is displayed for inspection. (Ref. Section 3.6 Current Day Plot).

When the required plot is displayed, the plot screen for any of the channels may be viewed by pressing the appropriate channel function key: to



After the required plot is displayed for a particular channel as described on the previous page, pressing the appropriate channel function key,  to , a second time will display the door information for the selected day. The following “door information” screen will be shown:

Note: If the door input is permanently disabled, or if it was disabled for that selected day, all information will be zero.

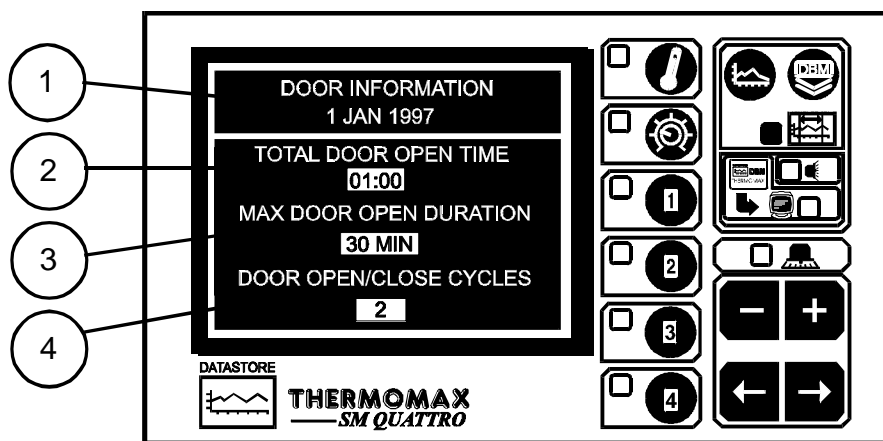

- 1 This shows the date as selected from the Plot History Function for which the door information below is valid.
- 2 This shows the “total door open time” in hours and minutes of the selected day.
- 3 This shows the longest time the door was open for, (in minutes), on the selected day. Please note that a maximum duration of 255 minutes only can be displayed.
- 4 This displays the number of times the door was opened then closed on the selected day.

Press any key to exit from this screen.

Note: The door information is not available on the current day plot screen (see section 3.6 – page 21).

3.8 DATA TRANSFER

The **SM QUATTRO** is supplied with an internal reusable 2.5 (Approx.) year databank. The contents of this databank may be transferred directly to the PC using the MASTERLINK Software, alternatively, the MASTERLINK Hardware may be used as an intermediate storage device to transfer data to a PC at a remote location.

3.8.1 Transferring Data using the Masterlink Software

NOTE: Before data can be transferred to the PC, the software must be set up on the PC, as per the MASTERLINK Software Manual.

- (a) Plug the 8 way SX plug of the 'PC Cable Assembly' into the SERIAL LINK of the SM QUATTRO.
- (b) Then plug the 9 way 'female D type' connector into any free serial port in the PC.

NOTE: For Panelmount units, read section 3.9 before attempting to download or print data.

3.8.2 Transferring Data to the Masterlink Hardware

- (a) Connect the 'MASTERLINK Cable Assembly', from the SERIAL LINK SX socket of the SM QUATTRO to the MASTERLINK Hardware.
- (b) Press the  key to reveal the following screen:

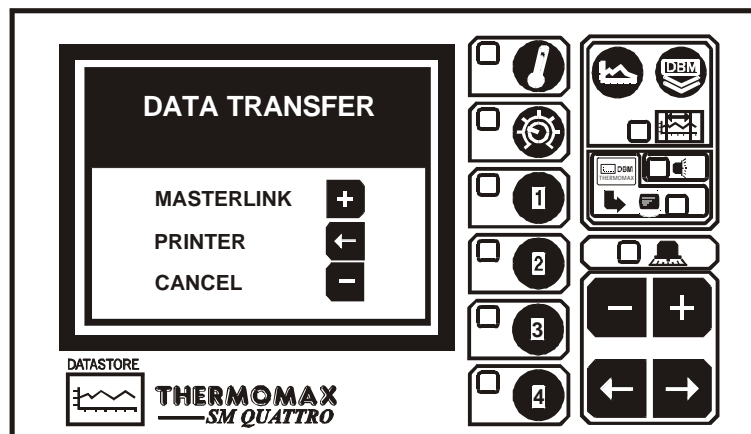

- (c) To download data to the Masterlink Hardware unit, (Part No. C0321), press the  key and the following screen will appear:

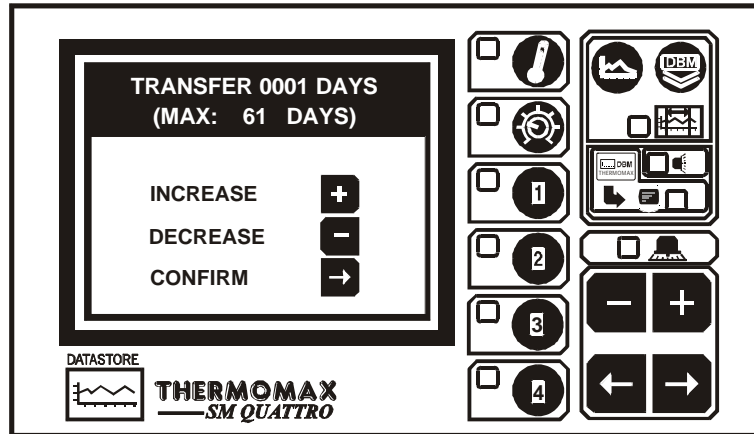

(d) The user can now choose any number of days, (starting from the current day), to transfer to the Masterlink Hardware – from 1 day up to the total number of days stored in the internal databank of the Thermomax unit. In this example, there are 61 days of data stored in the Databank.

(e) To increase or decrease the number of days to download, press the **+** or **-** key and then press the **→** key to confirm this. The following screen will appear to show the number of days' data left to be downloaded to the Masterlink Hardware.

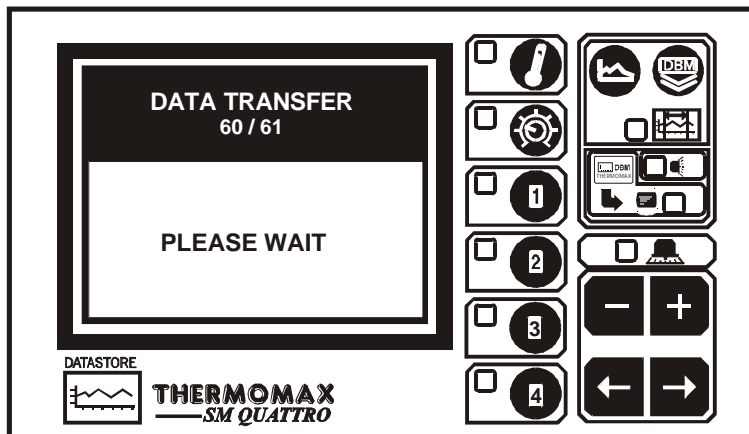



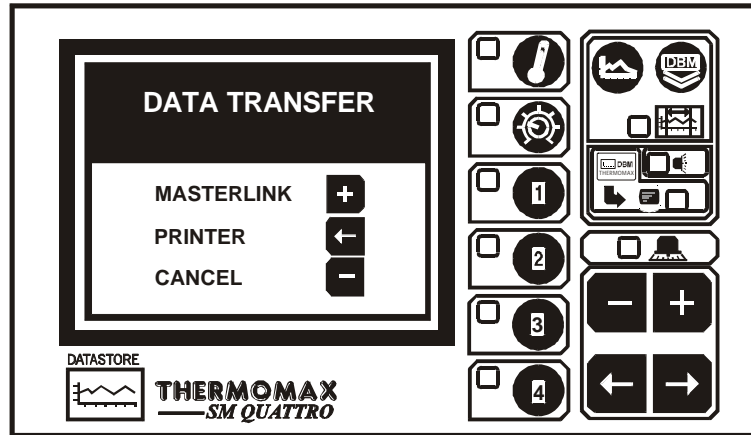

3.8.3 Printing Data to the Thermomax Serial Printer

- (a) Press the  key to reveal the following screen:

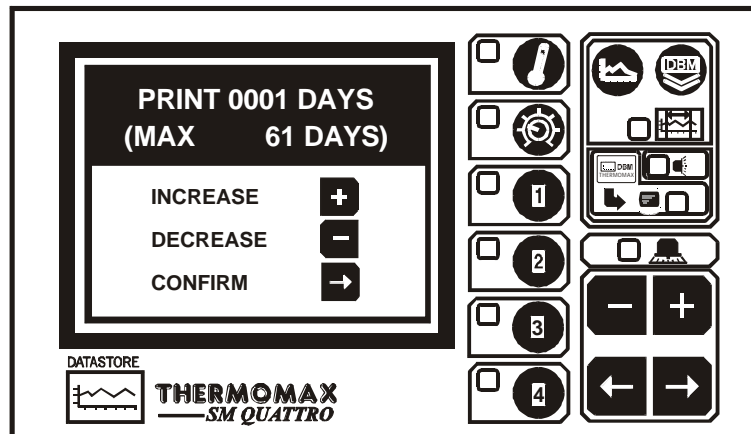

- (b) To print data directly to the serial printer, (Part No. A6747), press the  key and the following screen will appear:



- (c) The user can now choose any number of days, (starting from the current day), to print directly to the Thermomax serial Printer – from 1 day up to the total number of days stored in the internal databank of the Thermomax unit. In this example there are 61 days of data stored in the Databank.
- (d) To increase or decrease the number of days to print, press the  or  key and then press the  key to confirm this.

3.9 DATA TRANSFER - PANELMOUNT UNITS ONLY

The following functions / features have been added to the new SM Quattro Panelmount unit.

Mode 1 In Standard Mode the serial socket can be used for the following functions:

- Direct connection to PC
- Direct connection to Masterlink Hardware
- Direct connection to Thermomax Serial Printer

The unit is despatched from Thermomax in this mode.

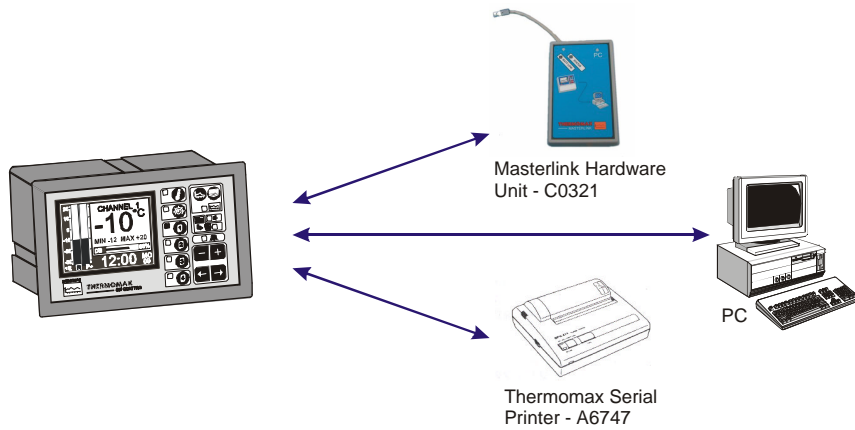

Mode 2 This mode is used to network up to 32 units to one PC, (see illustration below).

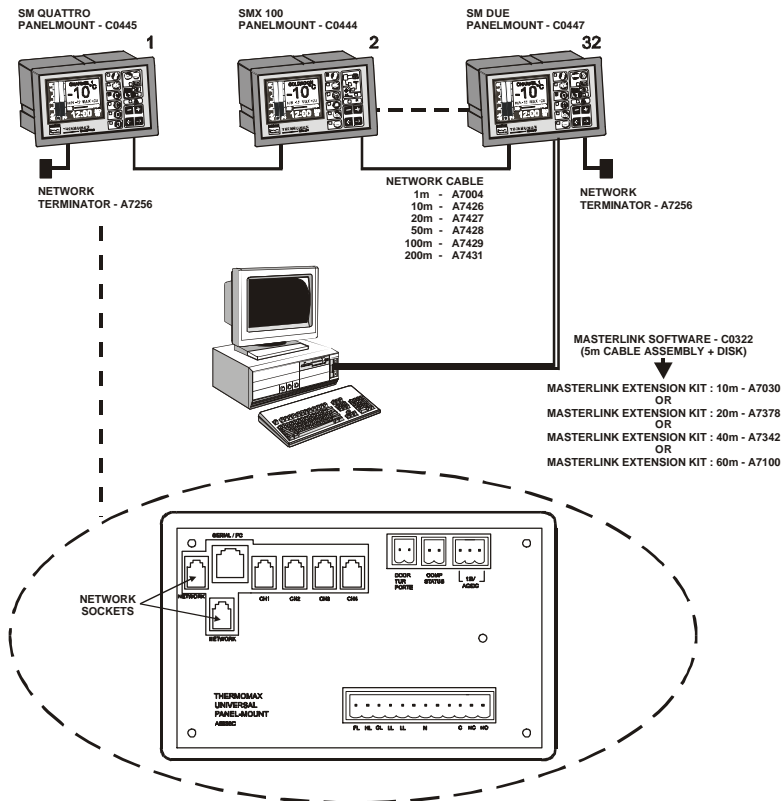

MODE 1 – STANDARD MODE (DISABLING NETWORK MODE)

If the network is enabled and the user tries to download data to the Masterlink Hardware or print directly to the Thermomax Serial Printer, the following screen will appear.

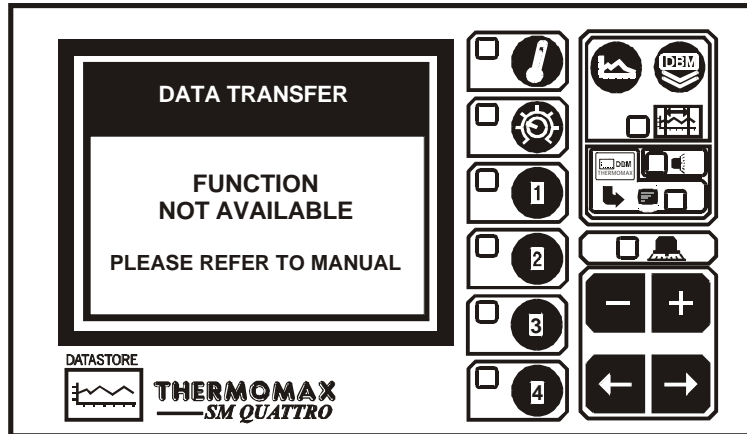

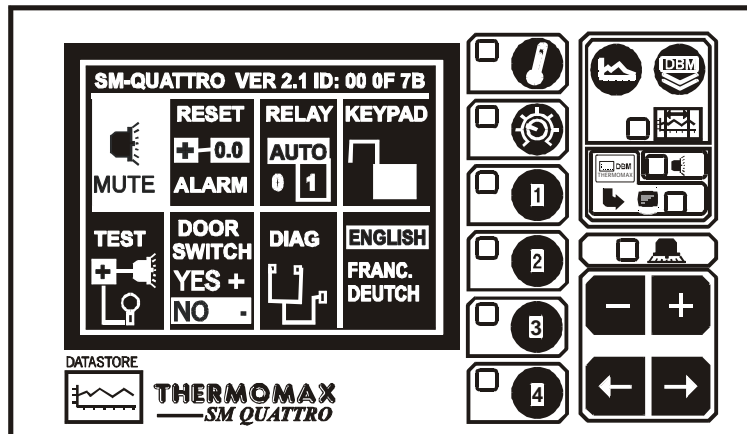

In order to download data to the Masterlink Hardware unit or print directly to a Thermomax Serial Printer, the network must be disabled.

To disable network, press the  key twice to reveal the following screen:



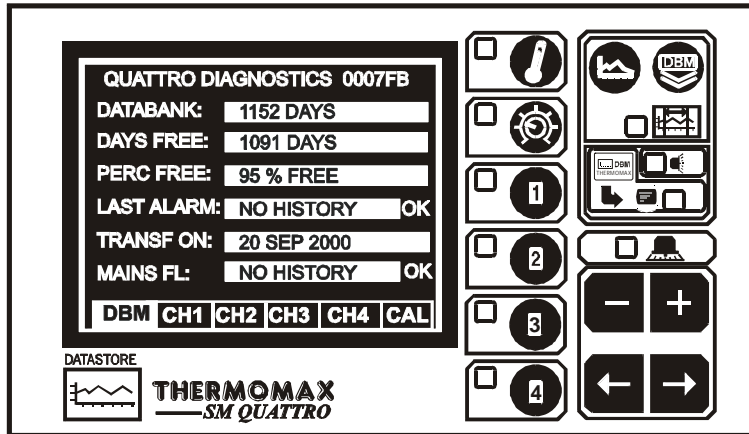

Select the  window by using the  key and press the  key to show the following screen:

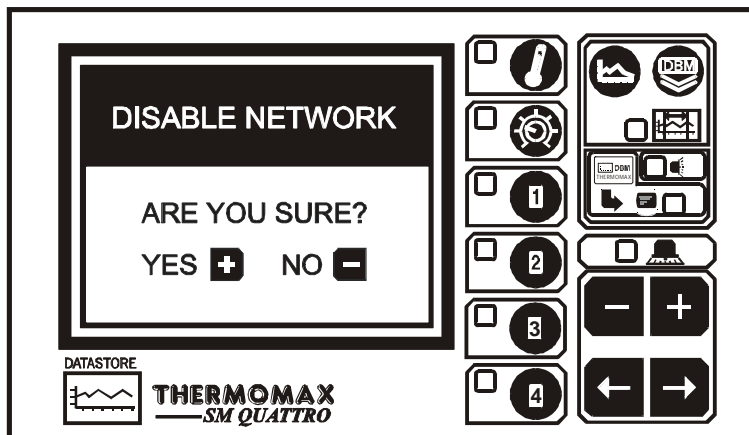

With this screen displayed, press and hold the  key for approximately 10 seconds. The following screen will appear:



To disable the network press the  key. (When the  key is pressed, the SM Quattro will switch off and back on again).

If you do not wish to disable the network, press the  key.

For instructions on how to download data from the SM Quattro Panelmount to the Masterlink Hardware or print data directly from the SM Quattro Panelmount to the Thermomax Serial Printer, read Section 3.8.

MODE 2 – NETWORK MODE (SELECTING NETWORK MODE)

To select the network mode, press the  key twice to reveal the following screen:

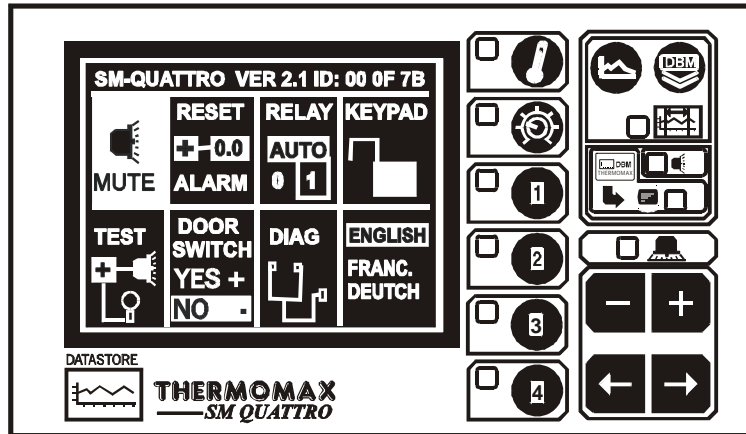

Select the  window by using the  key and press the  key to show the following screen:

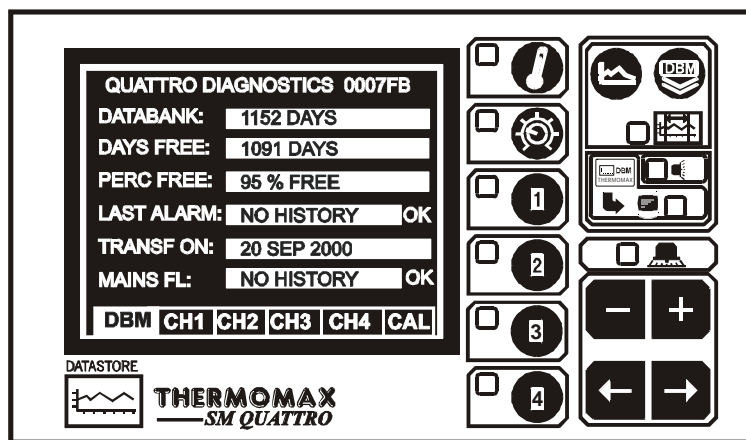

With this screen displayed, press and hold the  key for approximately 10 seconds. The following screen will appear:

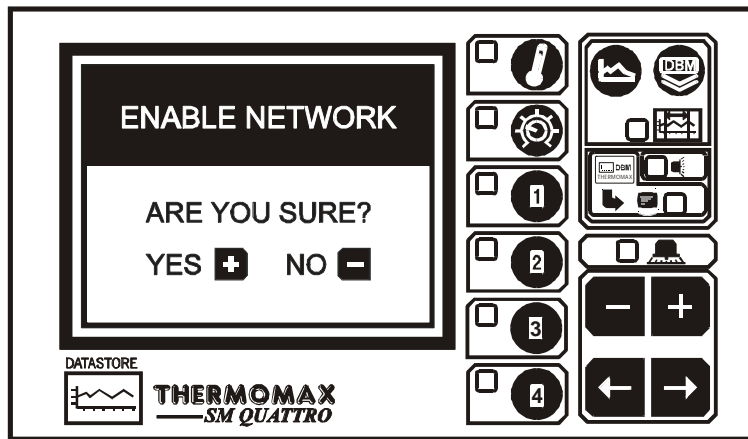

To enable the network press the **+** key. (When the **+** key is pressed, the SM Quattro will switch off and back on again).

If you do not wish to enable the network, press the **-** key.

SECTION 4 FAULT FINDING

- Problem:** Nothing happens when the unit is powered-up.
Cause / Remedy: One of the fuses could be blown – check and replace if necessary (refer to specifications for values). If the fuses blow again, contact the agent where the unit was purchased.
- Problem:** The temperature display is fluctuating.
Cause / Remedy: One of the sensor connections may be loose. If the sensor cable has been extended tighten connections and ensure all couplers are connected correctly.
- Problem:** Unable to set any of the parameters: Keypad will not operate.
Cause / Remedy: The Keypad Lock is on – See ‘Keypad Lock’ at the end of this manual.
- Problem:** The display screen is too dark or too faint.
Cause / Remedy: Adjust the display contrast to suit – See ‘Display Contrast’ in the MAIN SCREEN 1 section.
- Problem:** The System Alarm light is flashing once every 3 seconds.
Cause / Remedy: This indicates a system warning. Check the ‘CHANNEL DIAGNOSTICS’ screens for indication of the specific warning.
- Problem:** The System Alarm light is flashing and the audible sounder is active.
Cause / Remedy: This indicates a system fault or temperature alarm. Check the ‘CHANNEL DIAGNOSTICS’ screens for indication of the specific alarm.

SECTION 5 SPECIFICATIONS

ELECTRICAL:

Supply Voltage:	220-240V AC Single Phase
Ambient Temperature:	0°C to +40°C
Fuses:	2 X 1A 20mm Quick Blow
Relay Output:	Alarm: 5A changeover 3 pin isolated - (volt-free contacts) May be used for low or mains voltage

MECHANICAL:

Dimensions:	width: 165mm
	height: 160mm
	depth: 75mm
	weight: SM QUATTRO Unit: 0.96Kg
	Sensor: (each) 0.13Kg
Box Material:	Plastic
Front Panel:	Reverse printed
Display:	Large LCD supertwist graphics
SENSORS:	
Type:	SX™ PT 100 Platinum Film
Compensation:	3 wire compensated
Cable Length:	A variety of lengths are available from 5m to 50m.
Battery:	9V PP3 Rechargeable

PARTS LIST

SM QUATTRO	C0428
Sensor (5m Cable)	A6905

ACCESSORIES

Sensor (15m Cable)	A6915	Sensor Extender 50m	A6951
Sensor (25m Cable)	A6925	MASTERLINK Software	C0322
Sensor Extender 10m	A6911	MASTERLINK Hardware	C0321
Sensor Extender 20m	A6921	Humidity Sensor	C0429
Serial Printer	A6747	Network Terminators	A7256
Wall Bracket for Humidity Sensor			A6936
Serial Printer Cable Assembly : 5m (Black)			A7433
Network Connecting Cable : 1m (Ivory)			A7004
Network Connecting Cable : 10m (Ivory)			A7426
Network Connecting Cable : 20m (Ivory)			A7427
Network Connecting Cable : 50m (Ivory)			A7428
Network Connecting Cable : 100m (Ivory)			A7429
Network Connecting Cable : 200m (Ivory)			A7431
Masterlink Software Extension Kit : 10m (Ivory)			A7030
Masterlink Software Extension Kit : 20m (Ivory)			A7378
Masterlink Software Extension Kit : 40m (Ivory)			A7342
Masterlink Software Extension Kit : 60m (Ivory)			A7100



KEYPAD LOCK

The keypad may be locked or unlocked when this window is selected.

To lock, press the  key and hold for 5 seconds.

To unlock, press the  key and hold for 5 seconds.

When the keypad is locked, the SM QUATTRO enters into a security mode, which renders the unit 'tamper-proof'.

There are three functions for which the set keys ( / ) will still operate when the keypad is locked:

- (a) Display contrast (see 3.2.1 MAIN SCREEN 1);
- (b) Alarm mute and reset (see above);
- (c) Entering the Diagnostics Screen for viewing.(see section 3.4).

CE

This product has been tested to the EU EMC 89/336/EEC directive according to the Manufacturers report, which is available upon request.

This product is in conformance with the Low Voltage Directive 73/23/EEC.

Thermomax certifies that this datalogging and / or control device has been manufactured to an ISO 9002 Quality System.

Thermomax undertakes to repair or replace the device if same is shown to be defective in its manufacture and / or components, but Thermomax shall not be responsible for any other financial or economic loss (or any indirect loss) which may be incurred by the buyer / customer or others in the use of the device.

Any claim for repair or replacement must be made not later than 15 months after the date of manufacture.

SM QUATTRO PANELMOUNT

DIMENSIONAL DETAILS

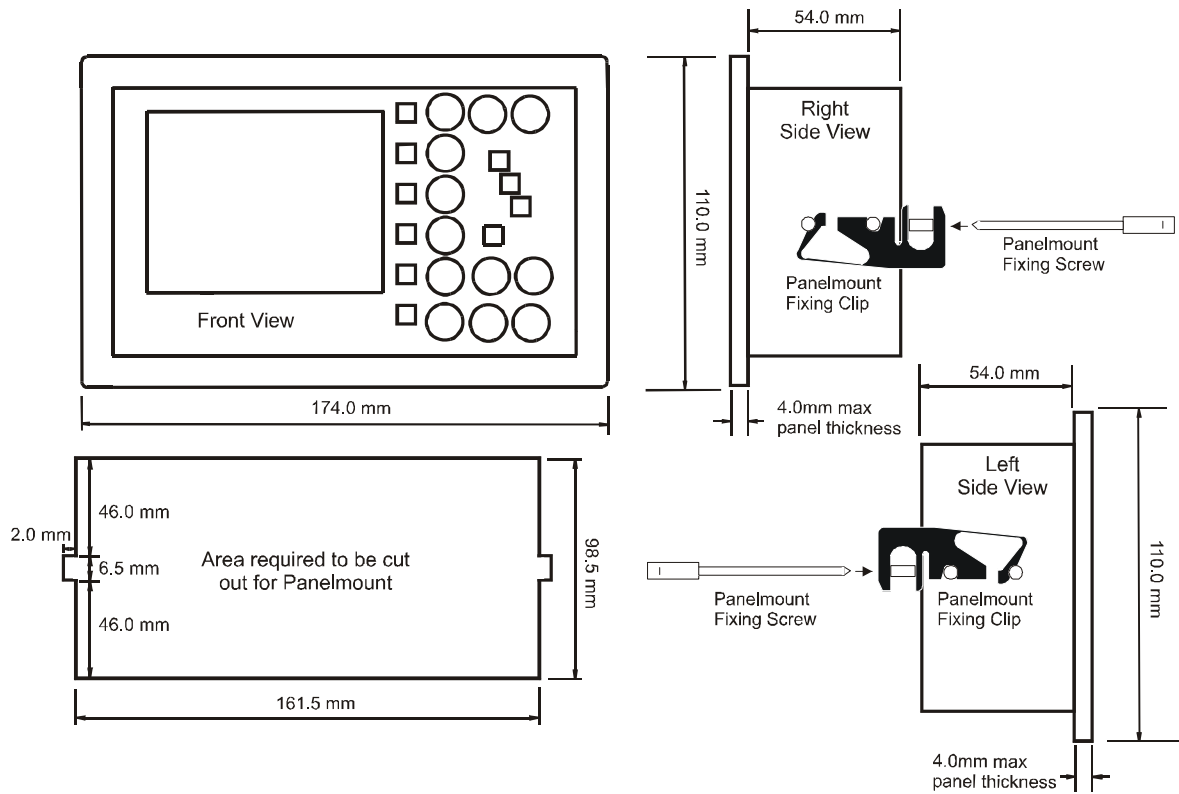

After inserting the Panelmount unit into the panel cut out, attach the two panelmount fixing clips (supplied), to the two studs at either side of the unit, (as above). The Panelmount unit is then held in place by the two Panelmount fixing screws (also supplied).

WIRING DIAGRAM

NOTE:
 For SM Quattro applications:
 CH1 = CH1
 CH2 = CH2
 CH3 = CH3
 CH4 = CH4

